

Kronoart®

Built to last™

Inspiring designs,
Enduring performance



kronosspann

Kronoart® high-quality architectural facade cladding is the ideal mix of next generation technical performance twinned with new levels of aesthetic freedom. It's a HPL board that's built to last, easy to work, immensely weatherproof, fire and UV resistant... Equally, Kronoart® offers inspiring creative scope. Whatever the character, size or function of the building, Kronoart® makes realising your idea a liberating and affordable process.

Contents

Introduction	01
Contents	02
Realize your inspiration	04
Performance art	06
Product Application	08
Public spaces	10
Work & Leisure	12
Living	14
Regeneration	16
Decor Collections	18
Color	20
Elements	26
Fundamentals	32
Product with Durability	40
Product Properties	42
Product Features	44
Maintenance	46
Processing	48
Facade Installation	52
General information	53
Rules of installation for elevation panels	54
Installation through visible fittings	58
Installation via concealed fittings	68
Installation through adhesive	72
Balcony Installation	82
General information	83
Installation of balcony panelling	87
Balcony partitions	90
Fastenings for balconies	92
Installation accessories	94
Supplier of fittings	95



08 Product Application



18 Decor Collections

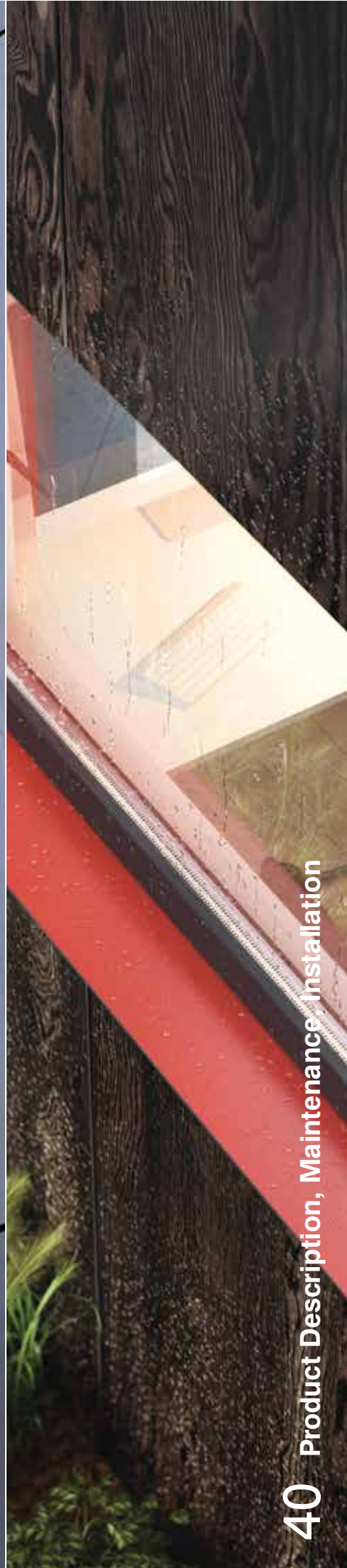

40 Product Description, Maintenance, Installation

Realize your inspiration

All too often, architectural ideas are compromised by cost or material limitations. Kronoart® means your inspiration is made real in full. If it's a bright and bold color-rich concept, if it's a natural contrast to industrial materials, if it's rugged and elemental, our three decor ranges offer the solutions you need to match your vision. Kronoart® is essentially highly flexible. The range

of styling possibilities and high definition surfaces mean almost limitless design freedom to apply your inspiration your way. The combination of functional performance and aesthetic scope makes Kronoart® as suitable for prestige domestic projects as it is for large scale industrial sites, commercial developments or public buildings.



Performance art

In parallel with giving you vast creative latitude, Kronoart® provides many practical performance advantages. The very high pressure, high temperature laminating process produces an easily handled material of great stability and strength – one that's exceptionally weather resistant and certified to EN438-6 type EDF. Kronoart® is suitable for suspended ventilated facades, facings, sunshields, external partitions, fences, railings and more.



HIGH DURABILITY

As a high pressure laminate (HPL) board, Kronoart® performs in the most demanding situations. The face layer will maintain its appearance unaltered over many years.



IMPACT RESISTANT

Both during installation and throughout its working life, Kronoart®'s strong laminate body and durable facing combine to produce a material that handles impact well.



UV STABILITY

Kronoart® is treated to maintain UV resistance over its long working life – you can be certain the appearance of your project remains constant for years to come.



ASBRASION RESISTANT

The face layer of Kronoart® is designed to resist marking during handling and cleaning, and by wind-blown particles such as grit and sand.



WEATHER RESISTANT

Extremes of weather and temperature have no adverse effect on Kronoart®, making it ideal for exposed locations, in vertical or horizontal planes.



WATER RESISTANT

High pressure, high temperature laminating and high-quality materials ensure Kronoart® remains impervious to water penetration.



EASY TO MAINTAIN

Low maintenance is part of Kronoart®'s specification; it has been designed to maximise the length of maintenance cycles.



EASY TO CLEAN

Kronoart®'s high definition facing is designed to shed dirt, and is easily cleaned when necessary.

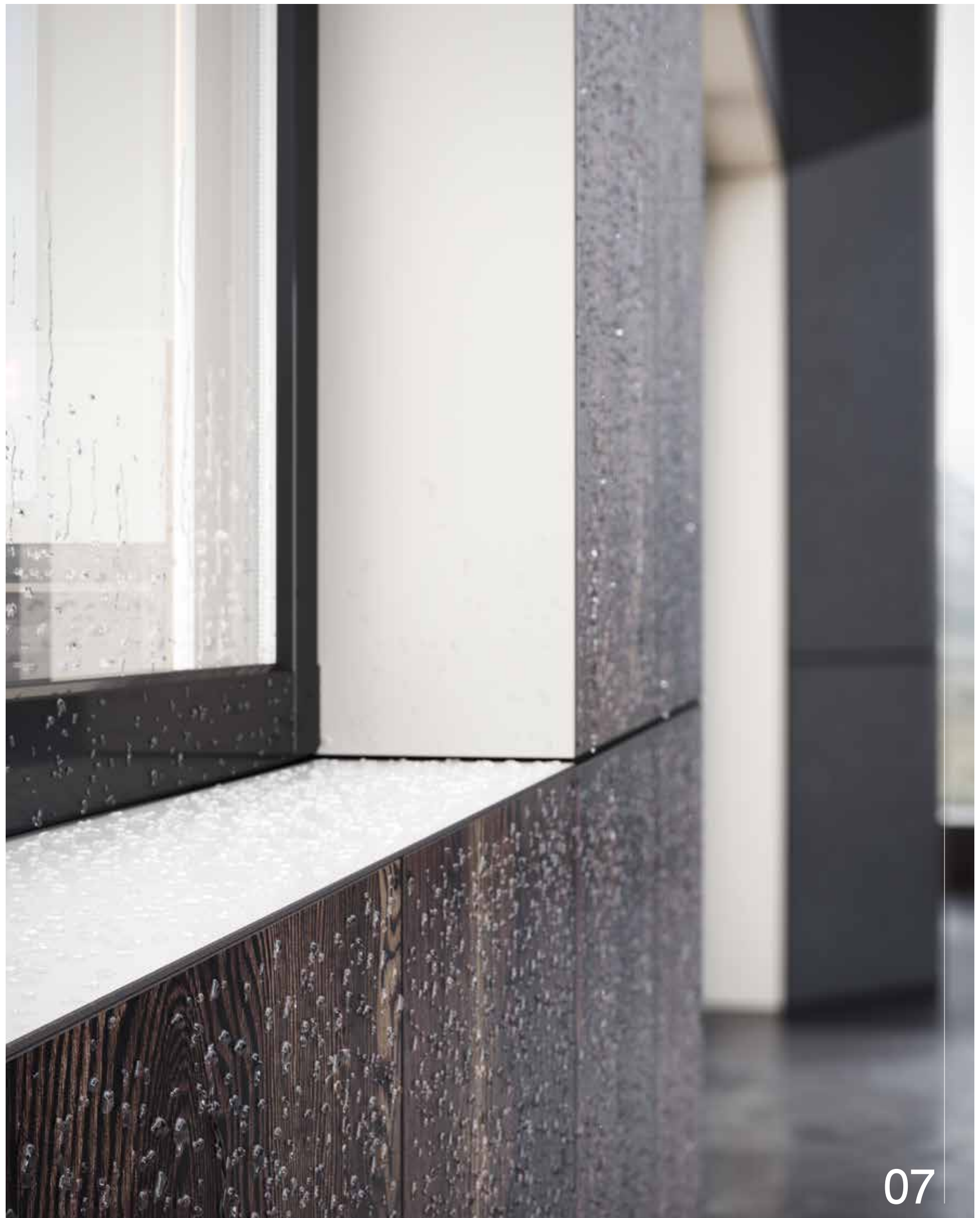

Product Application

**Whatever your project,
we've got it covered**

Kronoart® provides almost unlimited design options, an eye opening opportunity to create something special even on a limited budget. So a standout statement in a public space becomes a real possibility, or an inspirational work of urban regeneration using high definition effects or bold colors. The home or the workplace need never be dull again with the attainable use of surface decoration that's as practical as it is pleasing.



FACADE
CLADDINGS



BALCONIES



SUN BLINDS



10 Public spaces

12 Work & Leisure

14 Living

16 Regeneration

Public spaces

Integration describes Kronoart®'s application in the public buildings sector. Whatever the situation and the specification, the variety of decors in the three Kronoart® collections will help your ideas work beautifully in the public domain.

Building within civic and public scenarios can generate its own particular demands, challenges and opportunities. Again, it's Kronoart®'s inherent flexibility and design scope that makes it such an enabling option in this area. Style-wise you have a broad range of cladding directions to choose from, with high definition 3D decors that will mix happily with many different environments and architectural characters. Aesthetic considerations are equally matched by Kronoart®'s practical performance characteristics and accreditations. With Kronoart® you have a 360° solution for public design at your fingertips.



- Public buildings
- Government offices
- Hospitals
- Schools
- Education
- Health
- Museums
- Art galleries
- Libraries

- K237** BS Terra
- K244** BS Savanna
- 0134** BS Sunshine
- 0515** BS Sand
- 8533** BS Macchiato

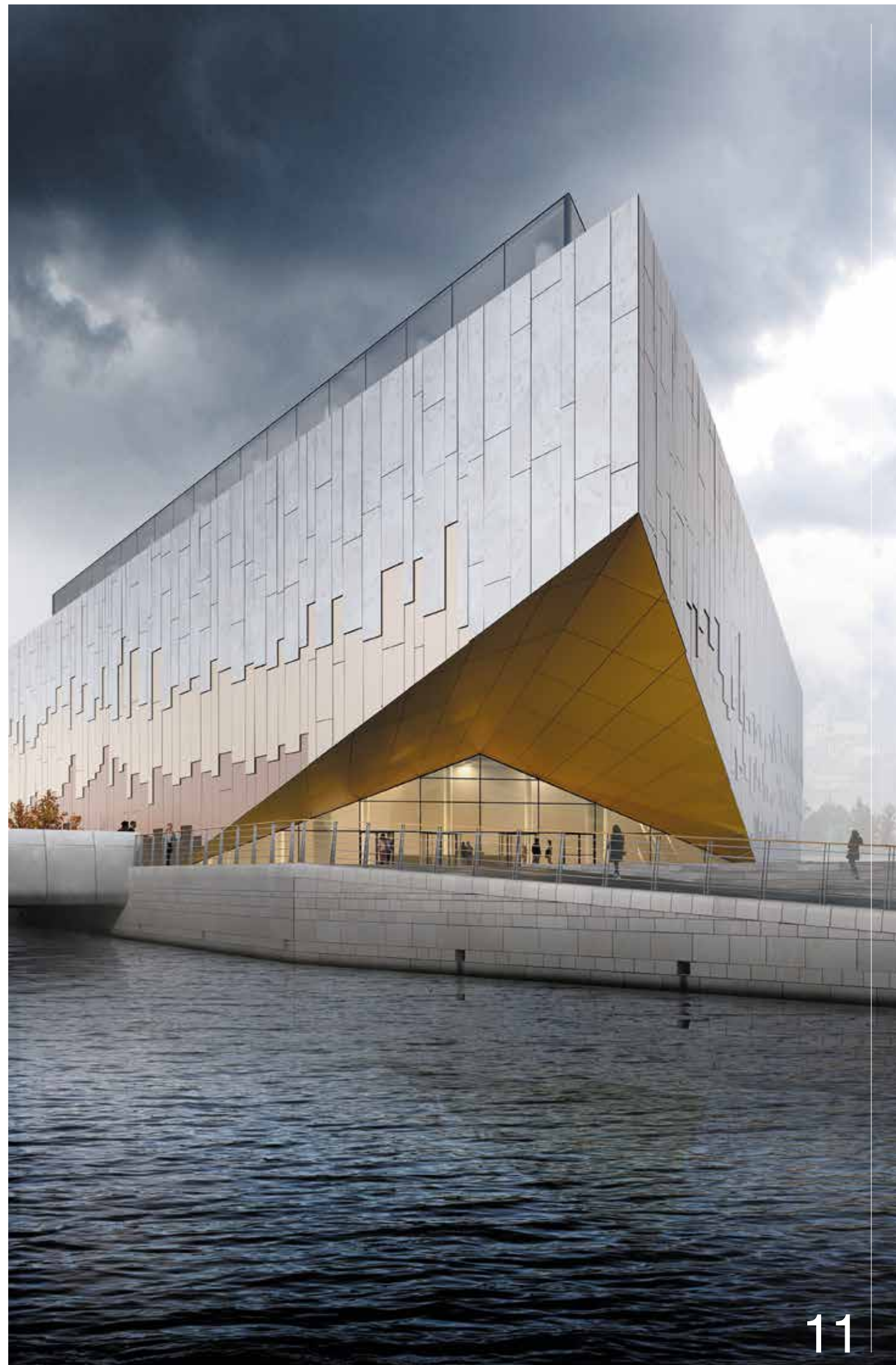

Work & Leisure

Kronoart® is the antidote for uniformity in office buildings. The vast array of decors and Kronoart®'s amazing versatility mean however a building needs to distinguish itself, you have the means to make the difference. Kronoart® high definition architectural cladding is a perfect solution for multifunction office buildings, on every scale. Whatever the building and its locale require visually, the three Kronoart® collections give you a wide range of aesthetic directions to choose from, from adding bright bold color to naturalistic wood character, or the substantial look of stone or steel. Kronoart®'s inherent flexibility makes it suitable for suspended ventilated facades, facade elements such as balconies and terraces, sun protection features, external partitions, fences and railings.



- Retail properties
- Commercial offices
- Warehouses
- Inner city regeneration
- Industrial buildings
- Sporting arenas
- Entertainment
- Leisure
- Theatres

- K234** BS Mercury
- 7123** BS Lemon Sorbet
- 7190** BS Mamba Green
- 8681** BS Brilliant White
- 8996** BS Ocean Green
- 9561** BS Oxide Green



Living

All Kronoart® products are manufactured to the standard of high-quality architectural cladding. They're the ideal facing solution for domestic projects of all kinds, balancing the finest level of finish with exceptional stability, easy installation and simple maintenance practices.

Kronoart® panels are ideally suited to the domestic scale. The high definition finish adds detail and interest with an unmistakable air of quality. Particularly in terms of contemporary buildings, clean simple lines combined with many tonal options help create a bespoke, premium look at a very ordinary cost. Kronoart® is also helpful in achieving insulation performance specifications, and its longevity and easy maintenance characteristics mean it's also an attractive practical option for owners.

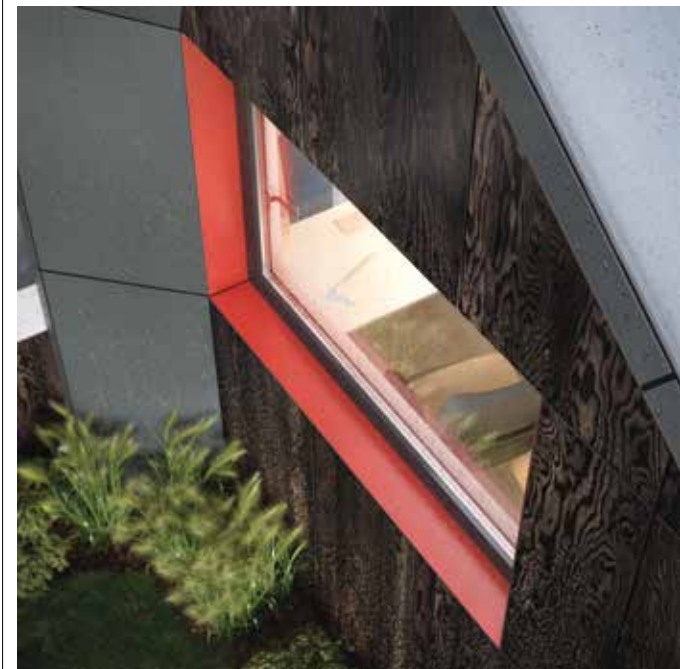

- Private housing
- Apartments
- Cooperative housing
- Housing associations
- Communal housing
- Collective housing

- K250** BS Dark Safari
- K098** BS Ceramic Red
- 0551** BS Peach
- 5981** BS Cashmere



Regeneration

Bringing existing buildings back from decline is a natural role for Kronoart® architectural cladding – its aesthetic scope and accredited performance mean that Kronoart® has the ability to revitalise and upgrade cost-effectively. With so much existing property showing its age and out-of-date specifications, regeneration is a pressing need in many locations worldwide. It's an area of the market that Kronoart® is highly suited to, given its advanced technical performance, ease of installation and extensive aesthetic scope. Whatever the crucial considerations – building performance, styling, budget constraints – Kronoart® cladding can be relied on to deliver to the most exacting contemporary specifications.



- Urban renewal
- Hospitals
- Schools
- Retail properties
- Commercial
- Warehouses
- Industrial
- Sport
- Education
- Health
- Entertainment
- Leisure

K254 WO California Pine
K097 BS Dusk Blue
K099 BS Midnight Blue
0245 BS Ocean



Decor Collections

A stunning new palette for you to play with

Pure clean colorways, dramatic stone and steel finishes or beautiful authentic looking woodgrains, these are the ingredients that Kronoart® provides for the ambitious designer. But why not mix them up, set tone against texture, contrast colors and materials with a flexibility of choice and simplicity of construction that provides an enhanced freedom of expression.



20 Color



26 Elements



32 Fundamentals

Color

Stand out or merge in, inspire a mood, set a scene; with this carefully selected palette of unicolors there are virtually endless creative opportunities.

The 48 uni colors in Kronoart®'s Color Collection enable you to create precise moods according to your design direction. Subtle, bold, naturalistic, contrasting or co-ordinating – you have the extensive palette you require to make your intended statement.

And having specified the look you have chosen for your project, Kronoart® can be relied on to perform and maintain its appearance for years to come, in the most demanding environments. All Kronoart® decors are exceptionally UV resistant; colors remain unaffected by even the strongest sunlight exposure. The same is true of Kronoart®'s weather resistance; with minimal maintenance your aesthetic will last for many years.



K234 BS Mercury
7123 BS Lemon Sorbet
7190 BS Mamba Green
8681 BS Brilliant White
8996 BS Ocean Green
9561 BS Oxide Green



Color

8681 BS Brilliant White

0101 BS Front White

0191 BS Cool Grey

0112 BS Stone Grey

0881 BS Aluminium

0197 BS Chinchilla Grey

0171 BS Slate Grey

6299 BS Cobalt Grey

0162 BS Graphite Grey

0164 BS Anthracite

0190 BS Black

0182 BS Dark Brown

8348 BS Bronze Age

7166 BS Latte

0301 BS Cappuccino

8533 BS Macchiato

K096 BS Clay Grey

5981 BS Cashmere

7045 BS Satin

5982 BS Mussel

0522 BS Beige

0515 BS Sand

0514 BS Ivory

7091 BS Crane



Color

Elements

An inspirational collection of character material effects lets you work with the look of concrete, stone, cast iron and steel in a way unrestricted by handling difficulties.

Elements is Kronoart®'s take on rugged, time-honoured construction materials. The collection is inspired by the characters of cast iron, concrete, stone and steel, and effectively evokes their sense of dependable permanence. Stone, cast iron and steel command respect. Original features using these materials in renovated buildings are often highlighted, their presence is celebrated. It's this love for substance and character that informs Kronoart®'s Elements collection. Elements reinvents traditional materials' appeal in an easily handled and installed next-generation format. The 13-strong choice of decors has that sought-after air of solidity that will last; the raw sense of texture and elemental tones can give new builds in modern materials a truly substantial character. But unlike their original counterparts, these color-fast finishes are very simple to maintain and clean, and exceptionally easy to work with.

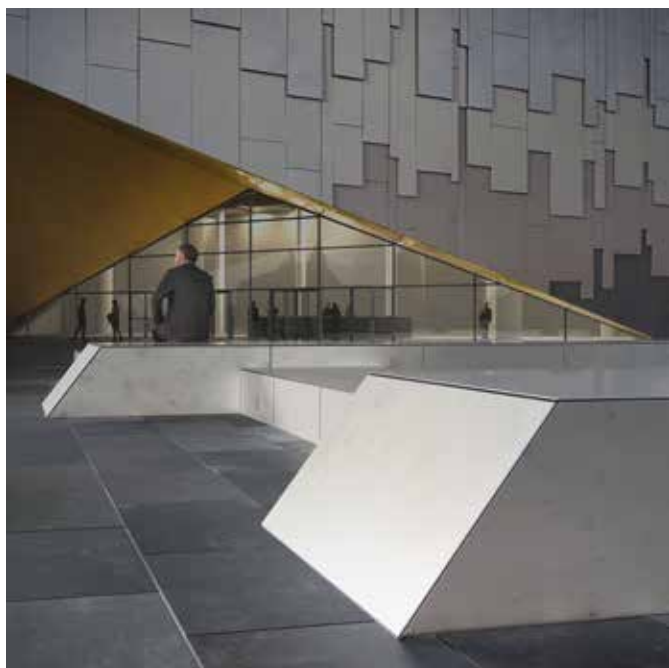

K237 BS Terra
K244 BS Savanna
0134 BS Sunshine
0515 BS Sand
8533 BS Macchiato



Elements

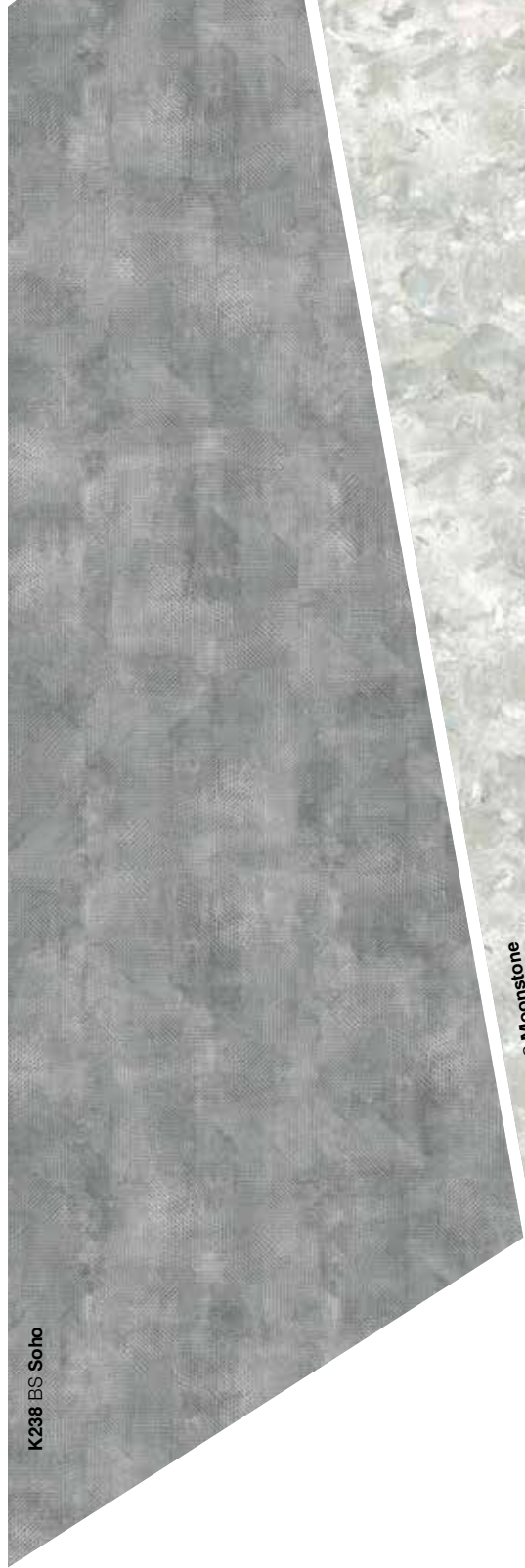

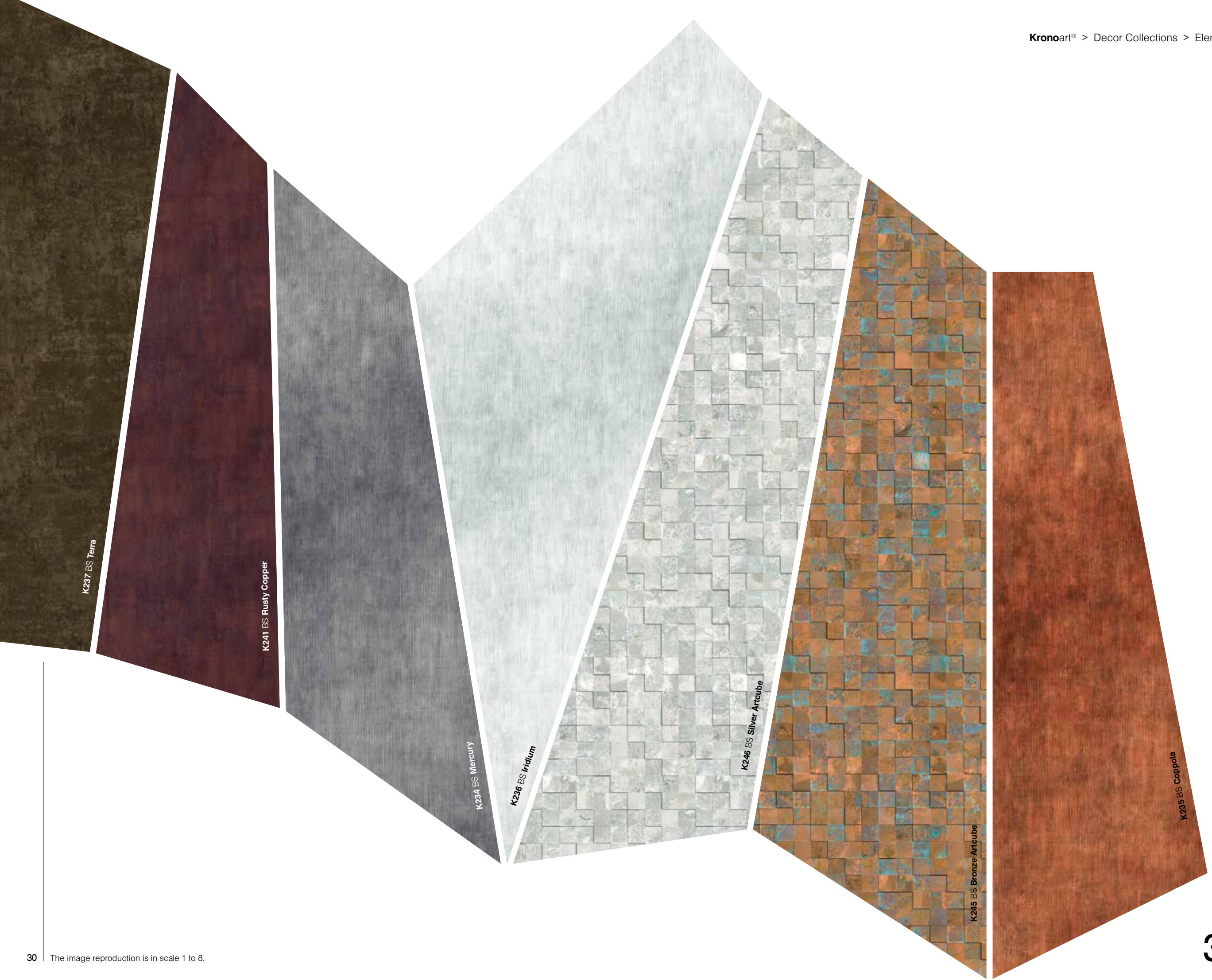

Elements

Fundamentals

The variety in color and pattern of woodgrains is what makes it such an enduring material to work with. Utilise the realistic appearance of wood in easy to manage panels.

The choice of colors and characters is wide, so many different moods can be created, with all the cost and consistency advantages of advanced high definition architectural cladding. The contrasts that can be achieved by pairing the uniformity and mechanistic lines of modern materials with the naturalness of wood is a powerful aesthetic. The 14 wood decors in the Fundamentals collection make such effects easy to achieve. Fundamentals range from dramatic dark decors to light white pine and warm mid tone oaks. They allow you to highlight features, bring in contrasts, soften the impact of concrete, add definition and rich grained character. Essentially you can enjoy all the aesthetic benefits of wood, with all the lower cost, simple installation and easy maintenance advantages of a technically advanced 21st century product.



0551 BS Peach
5981 BS Cashmere
K250 BS Dark Safari



Fundamentals



K249 BS Light Safari



D030 WO Sherwood Oak



K010 WO White Loft Pine



K254 WO California Pine



K252 WO Light Formwood



K253 WO Dark Formwood



K255 WO Havanna Pine



D038 BS Avignon Oak



K247 BS Sakura



K248 BS Kyoto



K251 BS Brandy Oak



K256 BS Bourbon Walnut



6046 BS Palisander



K250 BS Dark Safari

Decor overview

Number	Texture	Decor name	Collection	NCS	RAL	PMS
0101	BS	Front White	Color	S 0603-G40R	9010	-
0112	BS	Stone Grey	Color	S 2002-G	7038	420 M
0121	BS	Capri Blue	Color	S 2040-R80B	-	278 M
0125	BS	Royal Blue	Color	S 3065-R90B	-	-
0132	BS	Orange	Color	S 1070-Y40R	2000	151 M
0134	BS	Sunshine	Color	S 1060-Y	-	116 M
0149	BS	Simply Red	Color	S 2570-Y80R	3000	-
0162	BS	Graphite Grey	Color	S 7000-N	-	Cool Grey 11 M
0164	BS	Anthracite	Color	S 7502-B	-	-
0171	BS	Slate Grey	Color	S 5000-N	-	424 M
0182	BS	Dark Brown	Color	S 8010-Y20R	8014	4625 M
0190	BS	Black	Color	S 8502-R	-	419 M
0191	BS	Cool Grey	Color	S 1502	-	427 M
0197	BS	Chinchilla Grey	Color	S 4000-N	-	-
0244	BS	Petrol	Color	S 5020-B10G	-	-
0245	BS	Ocean	Color	S 3050-B30G	-	322 M
0301	BS	Cappuccino	Color	S 4010-Y10R	-	-
0514	BS	Ivory	Color	S 1005-G90Y	-	-
0515	BS	Sand	Color	S 1010-Y30R	-	-
0522	BS	Beige	Color	S 0907-G90Y	-	-
0551	BS	Peach	Color	S 2030-Y40R	-	-
0881	BS	Aluminium	Color	S 3005-R80B	-	428 M
5515	BS	Marmara Blue	Color	S 1555-B10G	-	-
5519	BS	Lime Grass	Color	S 0550-G60Y	-	380 M
5981	BS	Cashmere	Color	S 2002-Y50R	-	-
5982	BS	Mussel	Color	S 1505-G80Y	-	-
6299	BS	Cobalt Grey	Color	S 6502-Y	-	403 M
7031	BS	Crème	Color	S 0804-G90Y	-	-
7045	BS	Satin	Color	S 1505-Y80R	-	-
7063	BS	Pastel Green	Color	S 1005-B80G	-	441 M
7113	BS	Chilli Red	Color	S 1080-Y90R	-	179 M
7123	BS	Lemon Sorbet	Color	S 1020-G90Y	-	1205 M
7166	BS	Latté	Color	S 6005-Y20R	-	-
7176	BS	Flame	Color	S 1080-Y70R	-	172 M
7179	BS	Sky Blue	Color	S 1010-B	2004	-
7190	BS	Mamba Green	Color	S 1070-G30R	6018	368 M
8348	BS	Bronze Age	Color	S 7010-Y30R	-	-
8533	BS	Macchiato	Color	S 3010-Y70R	-	4745 M
8681	BS	Brilliant White	Color	S 0804-R90B	-	-
8984	BS	Navy Blue	Color	S 7020-R80B	5026	2965 M
8996	BS	Ocean Green	Color	S 2040-G60Y	-	-
9551	BS	Oxide Red	Color	S 4550-Y90R	3011	202 M
9561	BS	Oxide Green	Color	S 3060-G10Y	6001	348 M
K096	BS	Clay Grey	Color	S 3502-Y	-	407 M
K097	BS	Dusk Blue	Color	S 3010-B30G	-	-
K098	BS	Ceramic Red	Color	S 4040-Y80R	-	-
K099	BS	Midnight Blue	Color	S 5030-R80B	-	653 M
K100	BS	Raspberry Pink	Color	S 3050-R20B	-	215 M

Number	Texture	Decor name	Collection
K236	BS	Iridium	Elements
K237	BS	Terra	Elements
K244	BS	Savanna	Elements
K245	BS	Bronze Artcube	Elements
K246	BS	Silver Artcube	Elements
K234	BS	Mercury	Elements
K235	BS	Coppola	Elements
K238	BS	Soho	Elements
K239	BS	Brooklyn	Elements
K240	BS	Moonstone	Elements
K241	BS	Rusty Copper	Elements
K242	BS	Patchwork	Elements
K243	BS	Urban Slate	Elements
6046	BS	Palisander	Fundamentals
D030	WO	Sherwood Oak	Fundamentals
D038	BS	Avignon Oak	Fundamentals
K010	WO	White Loft Pine	Fundamentals
K247	BS	Sakura	Fundamentals
K248	BS	Kyoto	Fundamentals
K249	BS	Light Safari	Fundamentals
K250	BS	Dark Safari	Fundamentals
K251	BS	Brandy Oak	Fundamentals
K252	WO	Light Formwood	Fundamentals
K253	WO	Dark Formwood	Fundamentals
K254	WO	California Pine	Fundamentals
K255	WO	Havanna Pine	Fundamentals
K256	BS	Bourbon Walnut	Fundamentals

Board size

Format

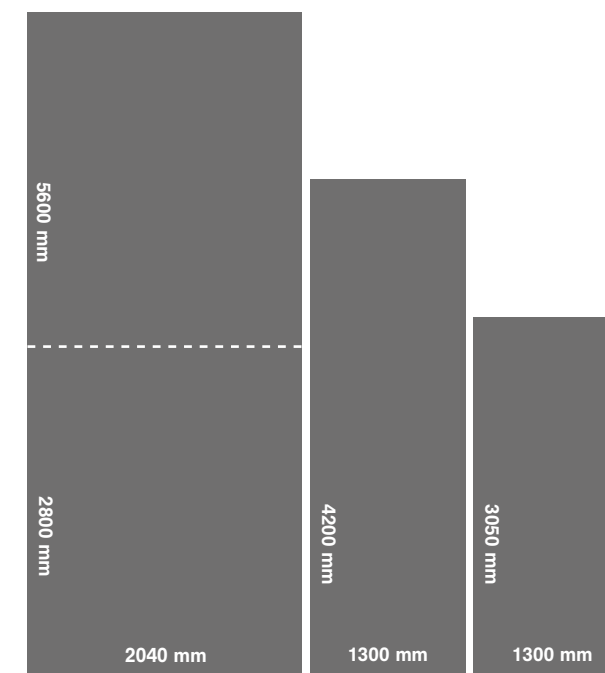

Thickness

6 mm
8 mm
10 mm

Both sides are UV protected.
Format tolerance according to EN 438-6.

Textures

Kronoart® panels are available in two durable textures.

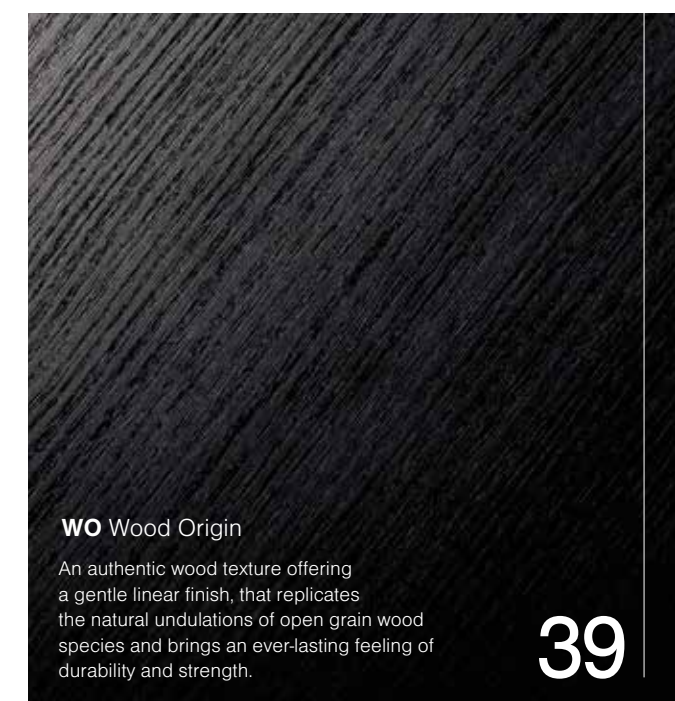

Product with Durability

Kronoart® > Product with Durability

Kronoart® is a high-quality, long-lasting solution for architectural facade claddings. Laminated under high pressure and at high temperature, its EN 438-6 Type EDF performance characteristics mean that Kronoart® is suited to even extreme weather conditions and the most demanding applications.

Kronoart® offers you the ideal combination of design freedom and exceptional durability. Across the world, architects and specifiers know that Kronoart® is the proven, versatile option for suspended ventilated facades, facings, sunshields, external partitions, fences and railings.

Application



FACADE CLADDINGS



BALCONIES



SUN BLINDS

Features



HIGH DURABILITY



IMPACT RESISTANT



UV STABILITY



ABRASION RESISTANT



WEATHER RESISTANT



WATER RESISTANT



EASY TO MAINTAIN



EASY TO CLEAN

Product Properties

Kronoart®'s unrivalled performance is due to its closed surface properties, topped by a layer of very durable varnish. This structure translates into high resistance to staining, impact damage and the effects of adverse environmental conditions - so Kronoart® is consequently extremely easy to clean and maintain. It's a winning combination; superior aesthetics paired with long-lasting, low maintenance characteristics. And naturally, Kronoart® panels are covered by a 10 year comprehensive guarantee, and provide fire retardancy in line with EN 13501-1 standards.

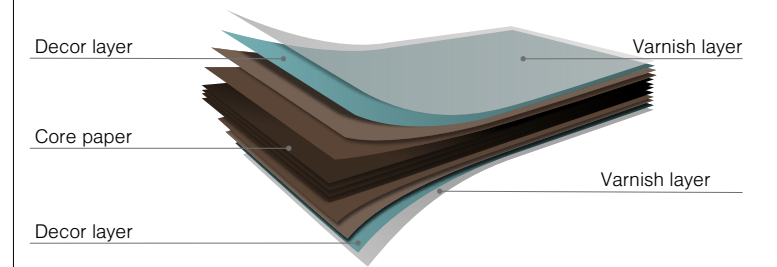

Technical Data

Parameter	Unit	Standard	Requirements value	Kronoart®
Thickness	mm	EN 438-2.5	$6.0 \leq t < 8.0 \pm 0.40$	$6.0 \leq t < 8.0 \pm 0.40$
			$8.0 \leq t < 12.0 \pm 0.50$	$8.0 \leq t < 12.0 \pm 0.50$
			$12.0 \leq t < 13.0 \pm 0.60$	$12.0 \leq t < 13.0 \pm 0.60$
Legth	mm	EN 438-2.6	+ 10 / - 0	+ 10 / - 0
Width	mm	EN 438-2.6	+ 10 / - 0	+ 10 / - 0
Flatness	mm/m	EN 438-2.9	$6.0 \leq t < 10.0 \leq 5.0$	$6.0 \leq t < 10.0 \leq 5.0$
			$t \geq 10.0 \leq 3.0$	$t \geq 10.0 \leq 3.0$
Straightness of edges	mm/m	EN 438-2.7	≤ 1.5	≤ 1.5
Squareness	mm/m	EN 438-2.8	≤ 1.5	≤ 1.5
Resistance to aging in artificial conditions, including UV	Grey scale rating	EN 438-2.29	≥ 3 (3000 h)	≥ 3 (3000 h)
			Appearance, grade	≥ 4 (3000 h)
Resistance to impact with large diameter ball	Drop height (mm)	EN 438-2.21	≥ 1800	≥ 1800
			Mass gain (%)	≤ 8
Resistance to wet conditions	Appearance, surface	EN 438-2.15	≥ 4	≥ 4
			Appearance, edge	≥ 3
Dimension stability at elevated temperature	Cumulative dimensional change (%)	EN 438-2.17	≤ 0.30 (along) ≤ 0.60 (across)	≤ 0.30 (along) ≤ 0.60 (across)
Flexual modulus	mPa	EN ISO 178	≥ 9000	≥ 9000
Flexual strength	mPa	EN ISO 178	≥ 80	≥ 80
Tensile strength	mPa	EN ISO 527-2	≥ 60	≥ 60
Density	g/cm ³	EN ISO 1183-1	≥ 1.35	≥ 1.35
Fire class	Classification	EN 13501-1	B-s1, d0	B-s1, d0

Tab. Technical parameters of facade panels

Product Features

Weather resistance

Sun, wind, rain, snow, humidity – Kronoart® remains unaffected by the elements both on its surface and within the panels. It's resistance to the effects UV exposure is particularly high. Extremes and rapid changes in temperature don't adversely affect Kronoart®.

Moisture resistance

Kronoart®'s fixing method helps dissipate moisture from the supporting structure, so with minimised condensation there's no opportunity for mold or fungi to gain a hold.

Fire resistance

Kronoart® panels comply with EN 13501, DIN 4102 and NRO. Under the influence of flame it does not melt or drip, there's no potential for explosion or flaking, and the panels maintain stability through prolonged exposure to fire. When eventually fire takes hold, smoke emission is low and presents no dangerous toxins.

Fire resistance rating

Standard	Fire resistance class
EN 13501	up to the class B-s1,d0
DIN	up to the class B1

Tab. Fire resistance rating for Kronoart panels

Sound insulation

Kronoart® panels can contribute to noise reduction. The extent of this is dependent on the thickness of the panels, their size and the number of holes made for fixing.

Vandal resistant

The ability of the panels to absorb impact without damage makes Kronoart® an ideal option in locations where there's a risk of vandalism.

Graffiti resistance

By use of an appropriate solvent, graffiti can be removed easily from the panels without compromising the highly durable finish.

Maintenance

Cleaning

It's very easy to maintain Kronoart® panels – most dirt can be removed simply by wiping with a dampened cloth or sponge. More stubborn staining can be handled with a suitable household detergent. The UV resistant panels may be cleaned with alcohol-based cleaners, but it's always good practice to test-clean an unobtrusive area before undertaking complete cleaning. Products containing abrasives are not recommended for use with Kronoart®. Pressure washing presents no problems, the jet should be directed from the bottom to top of each panel then laterally at a distance of 20-30 cm, finishing with a rinse of clean water. Jet wash pressure should not exceed 100 bar and water temperature should be no higher than 90-100°C.

Transport and handling

Once installed, Kronoart® panels offer exceptional durability, but in storage and handling surfaces and edges can be damaged if handled without care. The panels are supplied with foil protection covering, but it's recommended that when stacking dust and larger particles should be removed from between the boards. Panels should be stacked with thicker ones at the bottom, lighter panels towards the top, and care should be taken not to over-load the stack. The boards should be secured against slipping against each other in transit and handling, and the protective foil should not be exposed to continual direct sun or heat.

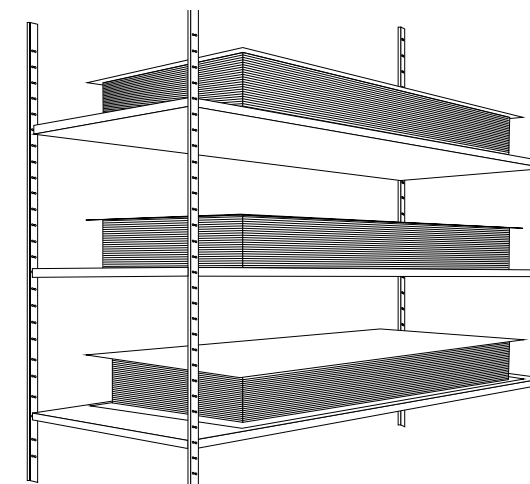

Storage

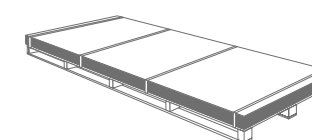

The Kronoart® panels must be stacked horizontally on flat, stable supporting panels. In order to keep the surface untouched, the covering plates must be left on the top of stack. Incorrect storage can lead to permanent deformation of the boards.

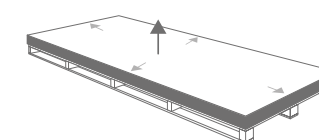

When loading and unloading, the panels must be lifted. Do not push or pull them over the edge.

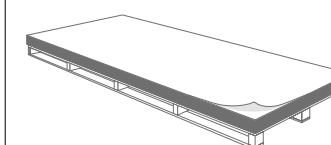

Do not stack the panels with faulty protection foil. Do not remove the foil before mounting or cutting if the panels will be stored.

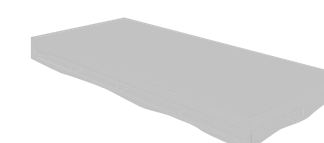

Keep the pallet securely covered to ensure no dust or dirt can get on or between the panels.

Processing

Safety precautions

The usual best-practice rules apply when operating machinery – appropriate personal protection and hi-vis clothing must be used and tools must be in good condition. The edges of unbevelled boards are sharp, so suitable anti-slip gloves should be worn. Cutting will create dust; protective eyewear and a dust mask are required. Ear defenders must be worn when operating machinery.

Preferred tools

Kronoart® panels are highly durable. Good quality tools are required to ensure clean cutting and drilling – diamond tipped drills and sharp, hardened metal blades are recommended. When machining boards they must be laid on clean, flat well-supported surfaces. Chips and particles should be removed to avoid marking the panels.

Tooth forms

HZ/FA (Beveled concave tooth)
Similar to WZ/FA and HZ/DZ but providing a higher machine longevity.

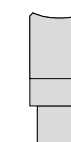

FZ/TR (Flat tooth/ Trapezoid tooth)
Suitable for cutting Kronoart® panels as well as laminates.

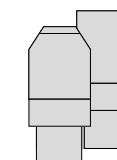

TR/TR (Trapezoid tooth/ Trapezoid tooth).
Best for cutting hard, abrasive laminates.

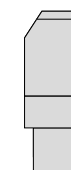

HZ/DZ (Pendulum tooth/ Concave tooth).
Useful when cutting on machines where scoring unit is not available.

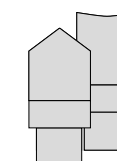

WZ/FA (Variable beveled tooth)
This type can be used interchangeably with the Pendulum/Concave tooth.

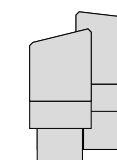

Machining of panels

To achieve optimal results when cutting an optimal feed rate (Vf) and cutting speed (Vc) ratio has to be maintained. Keeping the proper ratio is both beneficial for the final result of the cutting process as well as machine lifespan. To further increase cutting effectiveness we advise using diamond tipped tools. Moreover, cutting a single board will cause it to vibrate therefore precautions have to be taken in order to maintain a stable, fixed position.

Cutting speed formula

$$Vc = D \cdot \pi \cdot n / 60$$

Vc - cutting speed

D - tool diameter [m]

n - tool rotational speed [min.-1]

Feed speed

$$Vf = fz \cdot n \cdot z / 1000$$

Vf - feed rate [m/min.]

fz - tooth feed

n - tool rotational speed [min.-1]

z - number of teeth

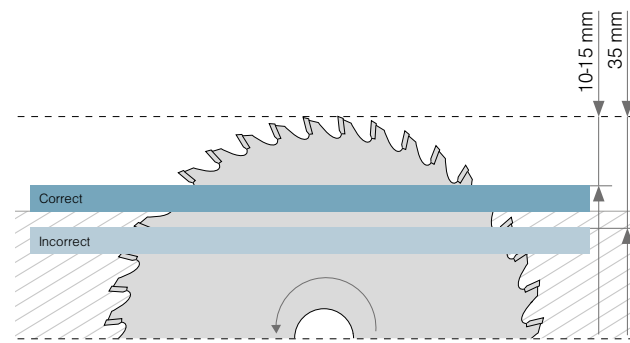

Fig. Circular, positive rake angle sawblades with a saw shaft under the workpiece.

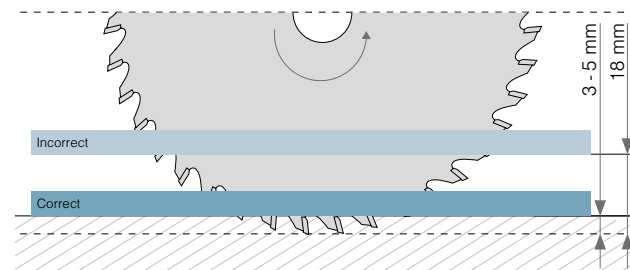

Fig. Circular, negative rake angle sawblades with a saw shaft under the workpiece.

Cutting with handheld tools

If a single cut is required you can use hard metal handheld saws. Blades should be sharp and have low set teeth. To make cutting easier and more precise use guiding rails.

Depending on the type of cut you want to achieve use a blade with an appropriate type of teeth. To find out which type is suitable for you follow the saw tooth guide we provided for you in this section.

Cutting with table saws

Splitting the board with a table saw might result in a jagged edge therefore we advise using a machine with a scoring unit and a device for applying pressure. This way the scoring blade will clear the outer layer of the board's surface ensuring a clear cut of the main saw blade. Because the scoring blade is thicker it prevents the main blade from directly touching the edges of the cut. Additionally, using a pressure device along with a scoring unit ensures a clean cut by securing the board in place. In order to perform maintenance of a circular saw with a conical scoring unit both widths need to be properly aligned.

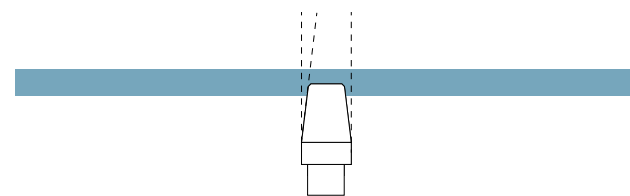
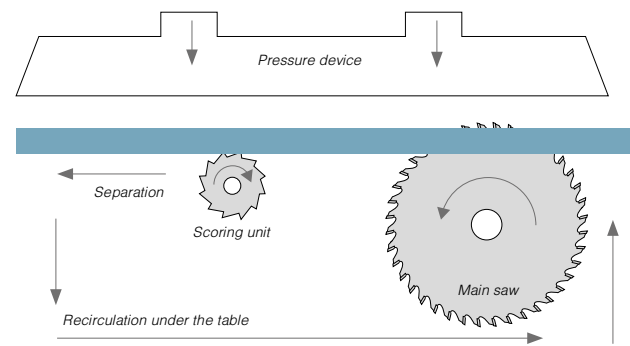

Fig. Cutting width rate of the scoring saw equals main saw's cutting width.

Drilling

For drilling either blind or through-holes it's best to use high durability twisted metal drills. Optimal drilling parameters oscillate between 2000 - 4000 RPM with a 1 - 3 m/min feed rate. While drilling make sure the board is secured and properly aligned. Because a high speed drill might damage the board's surface coating you should reduce RPM's by 50% when pulling out the drill.

Parallel mounting holes

Maintain a minimum hole depth of 25 mm for parallel connections.

Distance between the edge of the hole and the edge of the board should be at least 3 mm thick ($b - 2 \cdot a$).



Perpendicular blind holes

h - hole depth (board thickness - 1-1.5 mm)

d - hole diameter

(optimal size = 1 screw diameter - ~1 screw channel depth)

Correct screw placement depth = drilling depth - 1 mm.



Manual drilling

Make sure the rotation speed is at the maximum to avoid chipping and heating. Advance the drill smoothly. It is recommended to work on a backing panel that can be drilled (e.g. dense Particleboard or MDF).

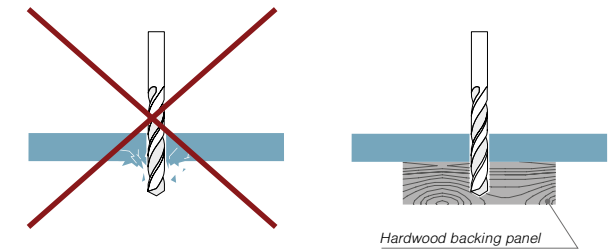

Finishing the edges

The edges do not require any special treatment but they can be machined for a special finish.

- The edge of the compact can be used by calibration, chamfering or beveling.
- It is essential to grind down sharp edges to avoid cuts when installing and after installation is complete.

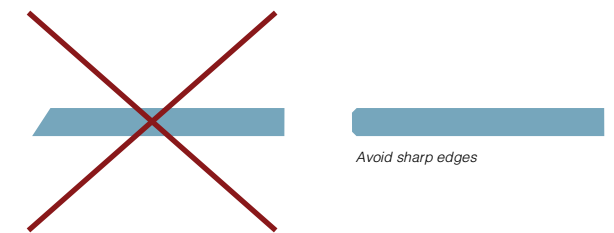

Facade Installation

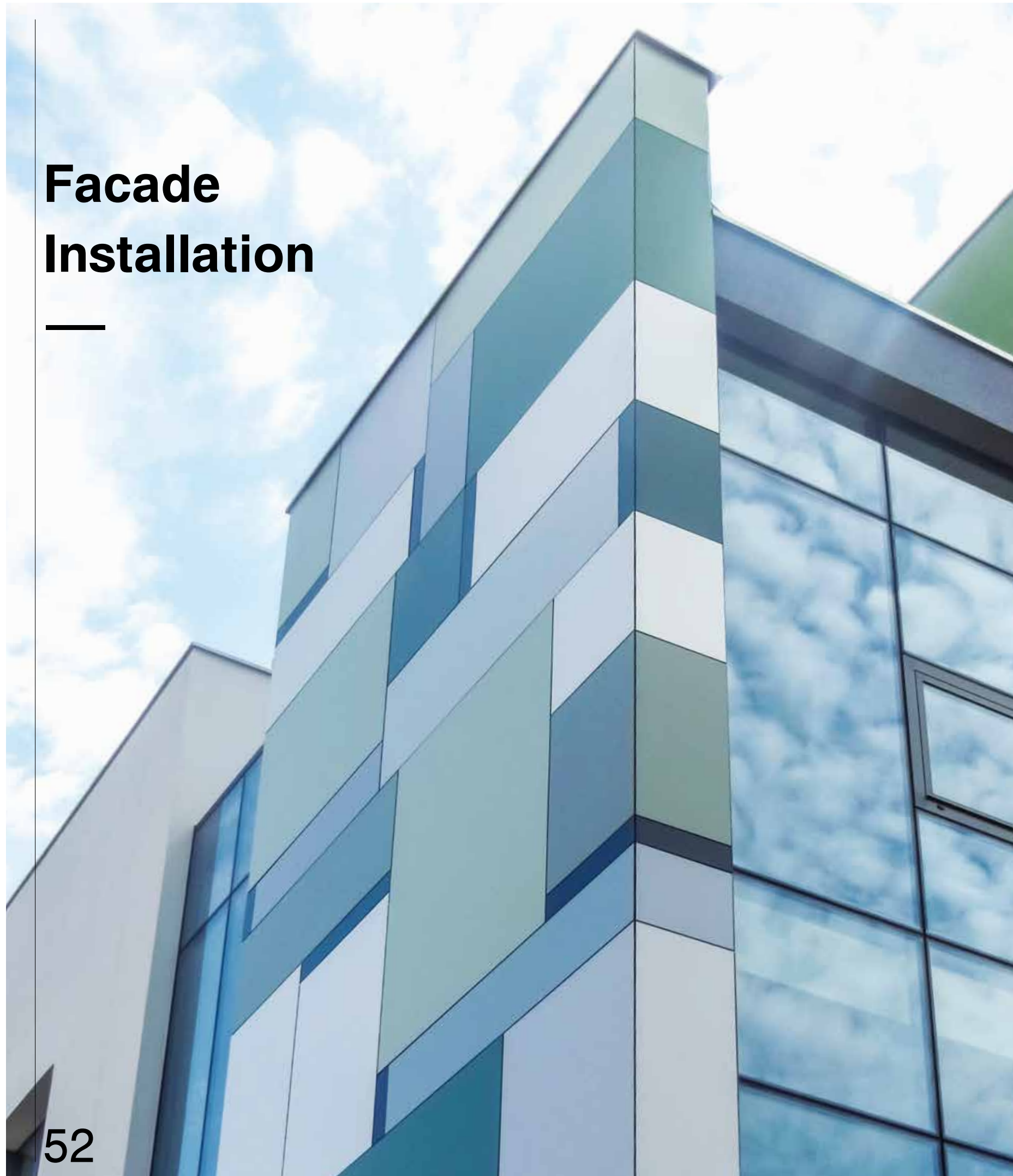

General information

Aesthetics aside, the technical purpose of ventilated facades is to protect the structure from weather and environmental conditions while providing effective thermal insulation.

Kronoart® is proven to meet these challenges over a long working life, without demanding maintenance schedules. Forming elevations from Kronoart®, you have the ability to insulate to the defined specification by selecting boards from a range of thicknesses, and create buildings with the desired levels of energy efficiency and CO₂ emissions. Winter heat retention can be maximized with Kronoart®, as can temperature control in summer or in high ambient heat locations.

Ventilated facades utilizing Kronoart® optimize the combined performance of structure and facade, protecting against moisture accumulation, while delivering thermal and acoustic insulation.

Additional points

The performance and installation parameters of the project should always be discussed with Kronoart® as part of the specification process, and the fixing system providers should also be involved at this stage. The relevant static calculations for the elevations must be completed. All subsequent installation operations should be performed by appropriately trained personnel.

Panel joining

The joining solution favored in most projects incorporates expansion gaps of 8 mm minimum. All fixings must be moisture and corrosion resistant, and gaps should be windproofed from the inside of the cavity.

If the panels utilized are of 8 mm thickness or more, they can be connected by tongue and groove joints, with the horizontal joints overlapped for a closed arrangement, as shown below.

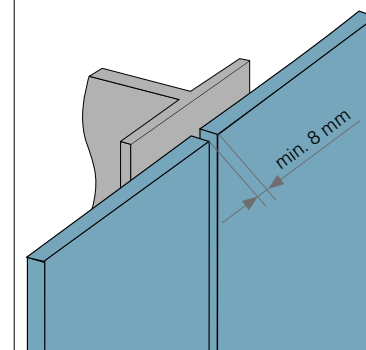

Fig. Open arrangement of gaps.

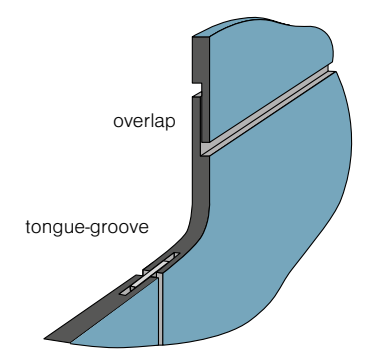

Fig. Closed arrangement of gaps.

Type of tongue	HPL	Aluminium
Dimension of tongue [mm]	3.0 x 30	2.0 x 30
Dimension of groove [mm]	3.3 x 15	2.3 x 15
Dimension of overlap [mm]		21

Tab. Close arrangement of gaps – recommended minimal parameters for tongue and groove

Rules of installation for elevation panels

Installation of the panels should be carried out only by qualified persons.

The panels can be fixed to the bearing structure using rivets, bolts/elevation screws, adhesive systems or staples fixed to rear side (invisible mechanical fixing).

All joints of panels with other elements and the substrate should be made in firm manner.

The Kronoart® panels can be fixed to metal substructure (aluminium, galvanized steel) or wooden substructure.

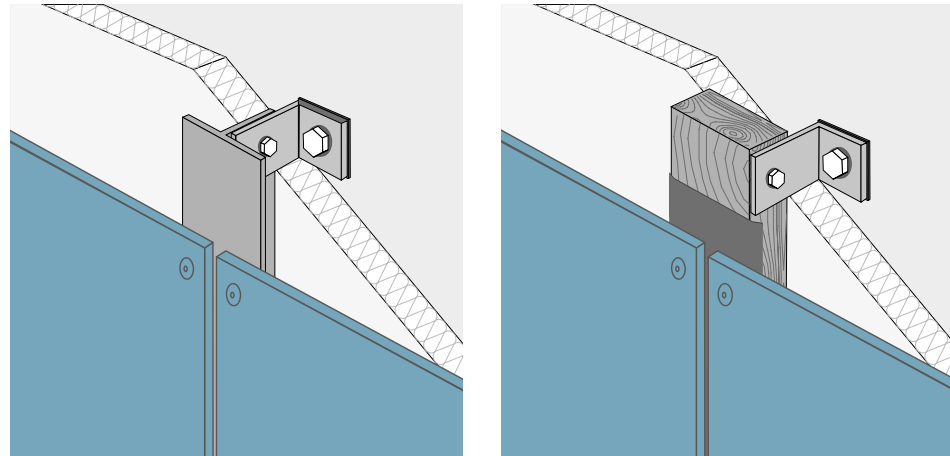

It's important to factor-in expected wind pressure exposure when selecting fixings, along with adhering to local building regulations. Calculations should be based on installation data for high pressure laminates.

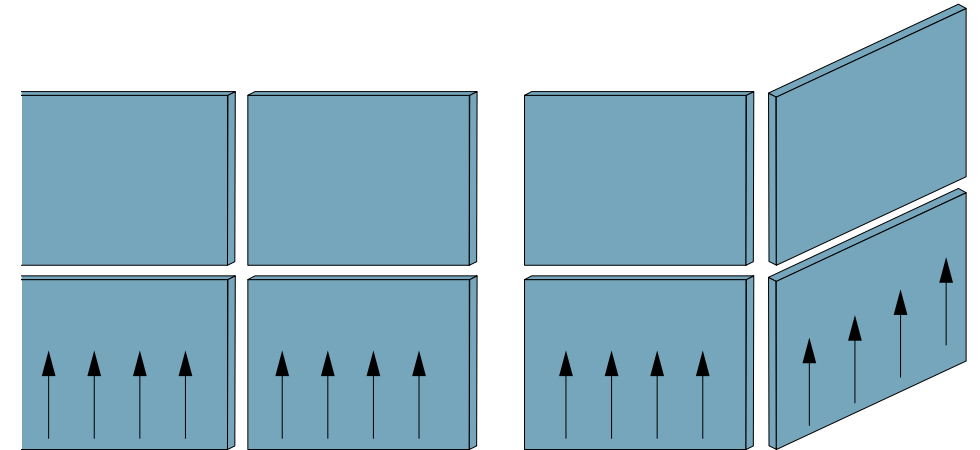

Fixing elements should be spaced so as to enable the panel moving (by appropriate arrangement of fixed and non-fixed holes).

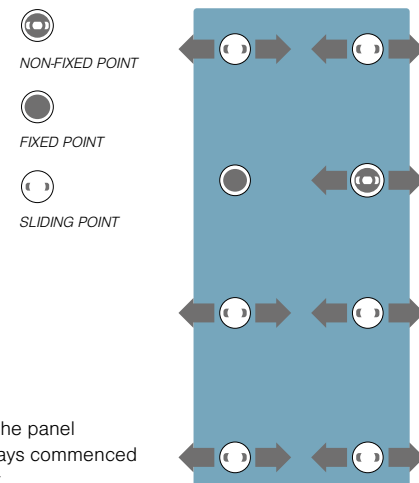
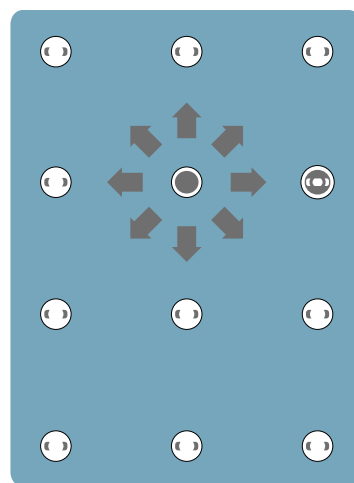

Installation of the panel should be always commenced from its center.

Installation of the lining from the Kronoart® panels should be carried out assuring constant ventilation of the elevation material from both sides.

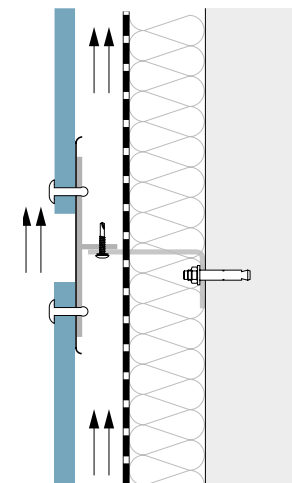

Recommended ventilation distance between thermo insulating board and the panel should be min. 20 mm. Lack of distance between the panel and the bearing structure and thermal insulation can cause condensation and deformation of the panels.

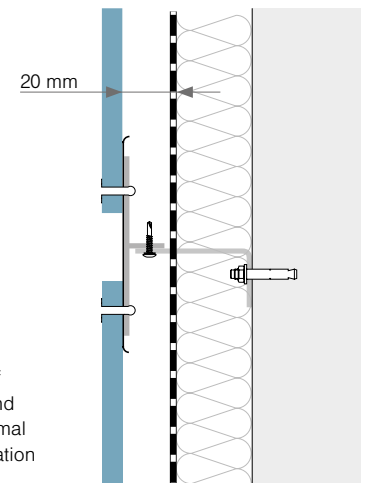

The line expansion crosswise and lengthwise should be taken into account when selecting the gap between subsequent formats assuming that the dimension of material can increase by about 2.5 mm per one current meter of the lining.

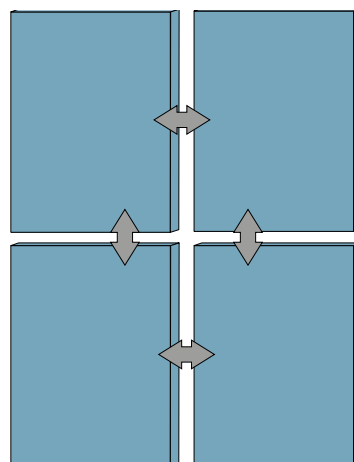

The spacers should be mounted only when necessary.

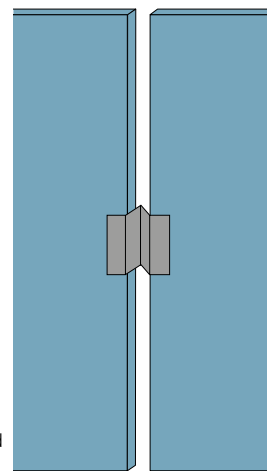

No panels should be fixed one on top of another to two differing substructure profiles – this is likely to compromise the expansion joint's effectiveness.

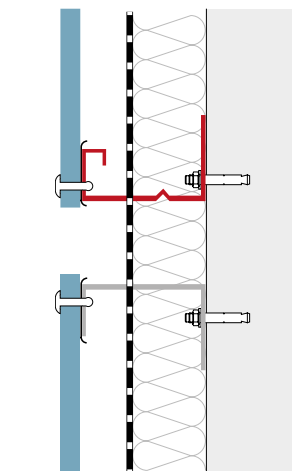

Solutions for corners

Selecting the best method of corner forming is dependent on the thickness of the panel used. We recommend a thickness of 8 mm or more, because this allows enough material depth to enable correct screw setting, or the machining of the groove for the tongue (the tongue should be 3 mm thick). The number of fixings and the distance between them will depend on the spacing of the substructure.

Types of corner finishings

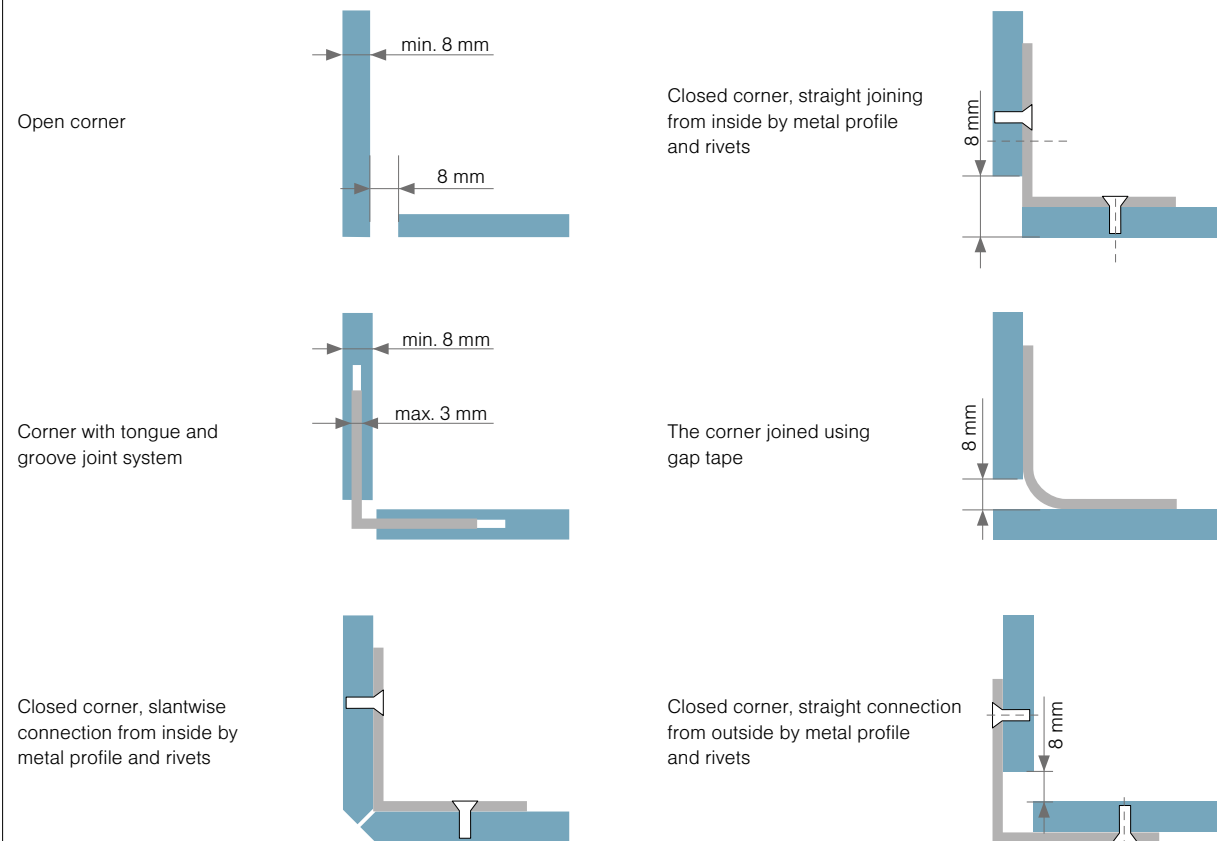

Fixing and connector elements

During installation and joining of elevation panels all elements should always be fixed observing one direction of fibres.

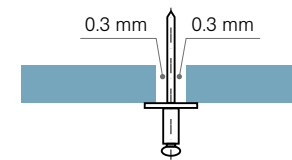

The head of the fixing element should be of such size that the hole in the panel is always covered. The fixing element of the non-fixed point should be positioned so as to enable movement of the panel.

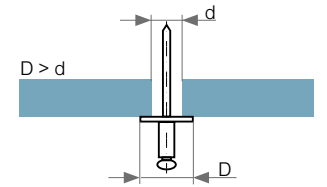

Rivets should be put using the articulated fixtures. The set distance from rivet head should make possible movement of elements in the drilled hole (clearance: +0.3 mm).

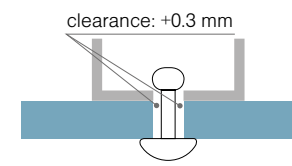

It is a good practice guaranteeing flexible fixing to make precise preliminary drilling with exactness to one millimeter.

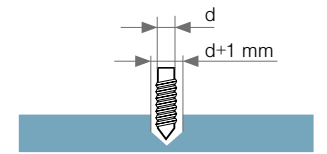

For rivets the recommended hole diameter in the facade panel for the fixed point is $\varnothing 5.1$ mm, and for the non-fixed point is $\varnothing 8.5$ mm. The diameter of the hole in the structure is $\varnothing 5.1$ mm.

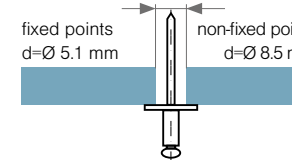

For torx screws the recommended diameters for: non-fixed points are $\varnothing 8.0$ mm, fixed points - $\varnothing 5.7$ mm.

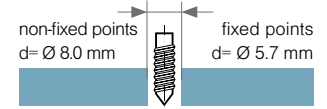

The center of the hole in the supporting structure should line up with the center of the hole in the panel. The holes should be drilled using the centering sleeve.

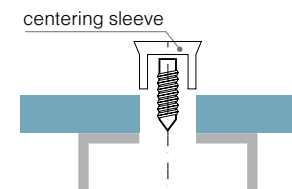

Do not use the sunk head screws!

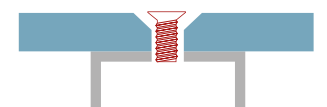

Dimensions of the profiles used depend on the thickness of panels (6, 8, 10 mm or more).



Only aluminium or from galvanized steel profiles should be used because of the resistance to corrosion and durability. In the case of other material of the substructure, care must be taken to protect it appropriately against weather conditions.

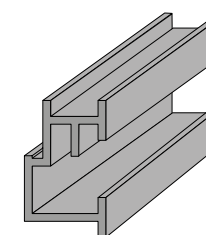

In order to obtain better cooperation in places of connections one can use rubber profiles from flexible EPDM.

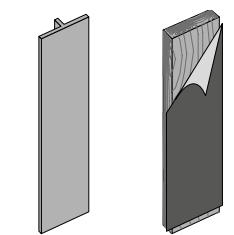

Installation through visible fittings

General information

The Kronoart® panels behave like wood in changing weather conditions - they expand when absorbing moisture and contract in dry air discharging moisture. Taking into consideration these properties, during installation the appropriate compensation clearance should be applied (the expansion gaps between panels 8-10 mm), assuring a possibility of uniform expansion of panels. To this end one fixed point should be made. The other fixing points can be made as non-fixed points.

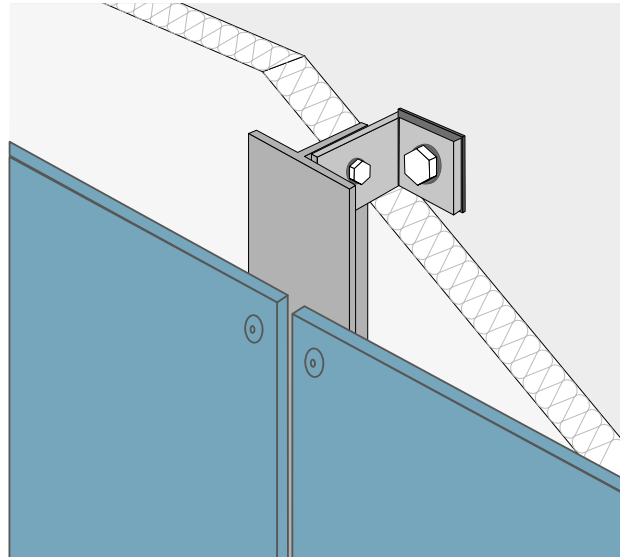

Fig. Visible fixing on metal substructure

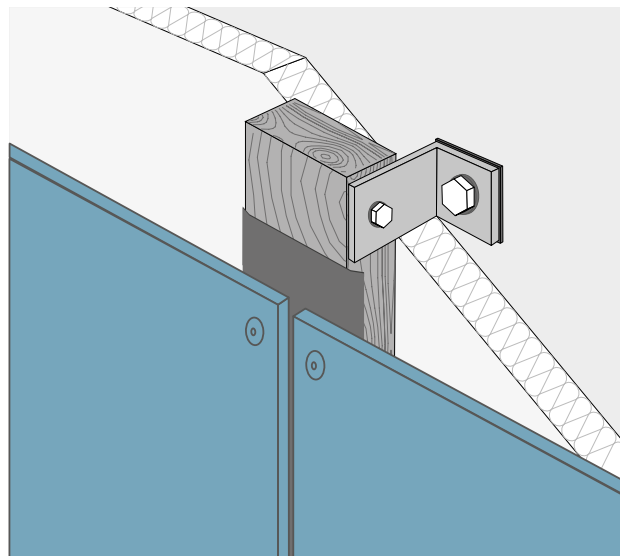

Fig. Visible fixing on wooden substructure

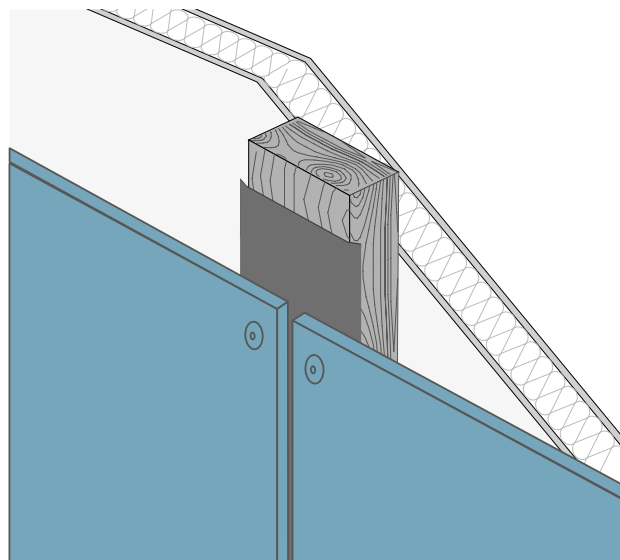
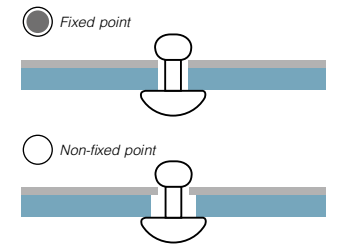

Fig. Visible fixing on timber frame buildings

Fixed point / Non-fixed point

Making a fixed point always guarantees even facing of panels both lengthwise and crosswise. For rivets the recommended diameter of a hole in the facade panel for the fixed point is $\varnothing 5.1$ mm, and for the non-fixed point is $\varnothing 8.5$ mm. The hole diameter in the construction: $\varnothing 5.1$ mm. For Torx screws the recommended diameters of holes for non-fixed points is $\varnothing 8.0$ mm, and for fixed points $\varnothing 5.7$ mm.



Distribution of installation holes

Below are given the suggested distances of fixings for the one-span installation of elevation panels.

	Thickness [mm]	max. D1 [mm]	max. D2 [mm]	a [mm]	b [mm]
One-span fixing					
	6	400	400	20 - 40	20
	8	550	500	20 - 40	20
	10	700	600	20 - 40	20

Tab. Distribution of joints - one span fixing

In the case of multi-span fixing of panel, it is recommended to distribute the installation holes as given in the table below.

	Thickness [mm]	max. D1 [mm]	max. D2 [mm]	a [mm]	b [mm]
Multi-span fixing					
	6	550	400	20 - 60	20 - 50
	8	700	500	20 - 80	20 - 60
	10	800	600	20 - 100	20 - 80

Tab. Distribution of joints - multi-span fixing

Generally, it can be assumed that the distance of joints from the panel edge should be maximum 10-fold of panel thickness and minimum 20 mm. For panels placed near the building corners the distance between the joints should be less than in the center part (taking into account the suction forces of wind).

Bending

Kronoart® panels can be formed into a curve without any special preparation – the physical and chemical properties of its laminate structure make this possible. The minimum bend radius achievable is: $R = 2$ m.

Sizes of installation panels

It is recommended not to exceed the elevation format surface over 4 m^2 , whereas the maximum acceptable side length should not exceed 3050 mm.

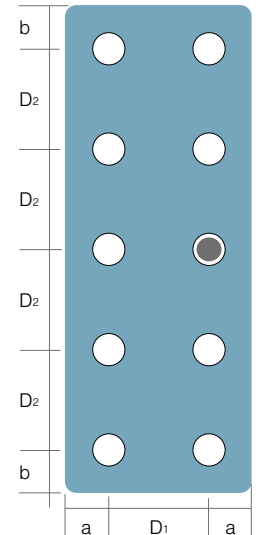

Fig. One-span fixing

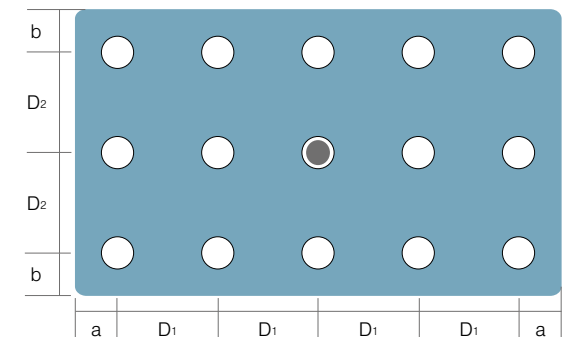

Fig. Multi-span fixing

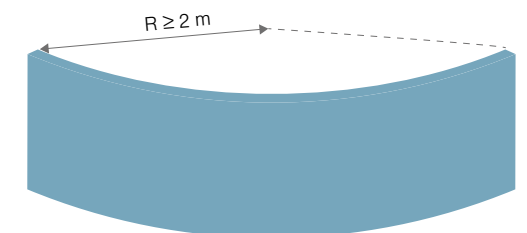

Fig. Bending of panels

Fixing elements

Coated rivets

Large head powder-coat rivets should be used on systems with visible fixings, attached to aluminum framework according to certificated parameters.

Element	Type of material	No of material
Sleeve	Al Mg 5	3.3555.10
Stem	stainless steel	1.4541 (Alfo®); 1.4301 (SFS)

Tab. Parameters of blind rivets

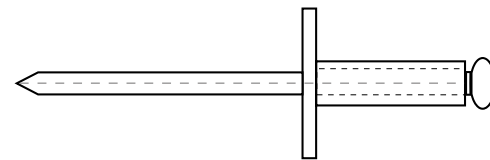

Fig. Blind rivet, closed from one side, painted

Diameter Ø d / Length L [mm]	5/18	5/21
Max. thickness of material [mm]	12	15
Diameter Ø d1 [mm]	2.7	2.7
Diameter Ø D [mm]	14	14
Catalogue no. (Alfo®)	12250180/14	12250210/14
Catalogue no. (SFS)	AP1450180-S	AP1450210-S
Quantity	500 / carton	500 / carton

Tab. Technical data of the recommended connectors

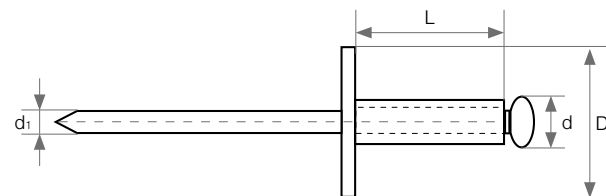

Fig. Blind rivet - construction and dimensions

Breaking force of the rivets is 4.4 – 5.2 kN.

In the majority of cases the specifications listed above can be followed for adequate fixing. Riveting tools and accessories are available, including manual and machine riveting options, distancing tips, centering tools for drilling, and a positioning tip for centering the preliminary hole.

Torx 20 screws

These are intended for use with timber supporting frames. They're made from corrosion resistant austenitic stainless steel, finished in powder coated colors. They can be used without washers, with single or double threads.

No of material	1.4301
Diameter Ø d2 [mm]	12
Diameter Ø d1 [mm]	5.2
Length L [mm]	24
Screw driver tip	TORX T20W
Pitch of the screw P [mm]	2.2

Tab. Technical data of fitting screws Torx

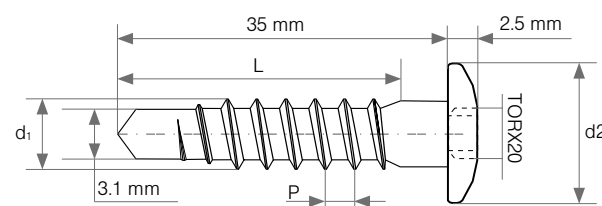

Fig. Fixing screw Torx - construction and dimensions

- d1 thread diameter
- d2 head diameter
- L length
- P pitch of the screw

Self-drilling stainless fasteners

SX-L12 (SFS) fasteners achieve a neat, almost invisible finish, with the flat screw heads being powder coated in colors to match the panels. They may be utilized with steel or aluminum support structures.

Element	Type of material	No of material
Connector SX	austenitic stainless steel	grade acc. to AISI 304 (1.4301 wg. PN-EN)
Washer S	austenitic stainless steel	grade acc. to AISI 304 (1.4301 wg. PN-EN)

Tab. Self-drilling connectors - materials used.

Heads of connectors, depending on version:

- L12 - irius® Ø 12 mm,
- D12 - flat head Ø 12 mm with a seat T25.
- D10 - flat head Ø 10 mm with a seat T20.

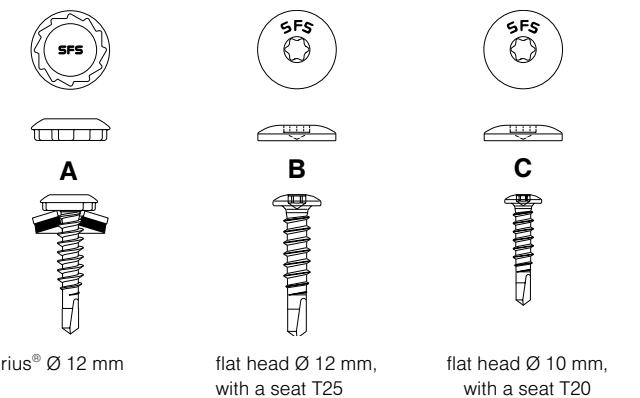

Product	Type	VD	KL	HD	W	d	L	Application
A	SX	3/	15/	L12	S16	5.5x	32	VD max. steel: 3.0 mm t max. steel: 2.5 mm
B	SX	3/	15/	D12		5.5x	30	VD max. steel: 3.0 mm t max. steel: 2.5 mm
C	SX	3/	15/	D10/		5.5x	25	VD max. steel: 3.0 mm t max. steel: 2.5 mm t min. steel: 2.0 mm t min. aluminium: 2.0 mm

Tab. Symbols and parameters of connectors (SFS). All dimensions in mm.

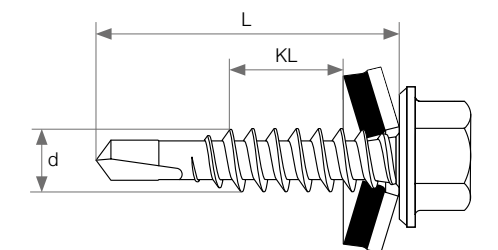

Fig. Self-drilling connector - construction.

- KL thickness of joined elements
- d thread diameter
- L total length
- VD maximum drilling capability
- HD type of head/ seat
- W material and diameter of washer
- t thickness of substrate

Visible fixing on metal substructure

horizontal cross-section

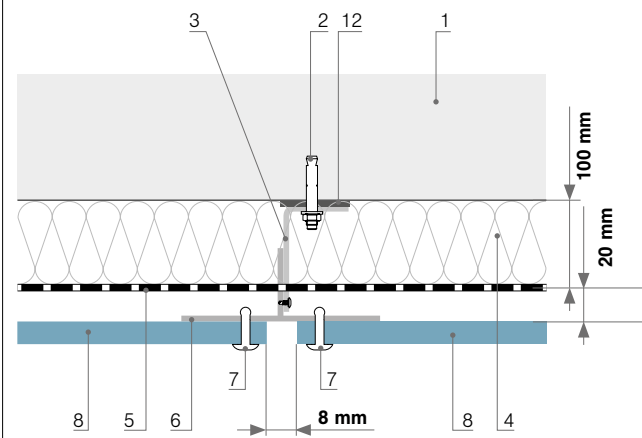

Fig. Draft A-A
I-Beam connector

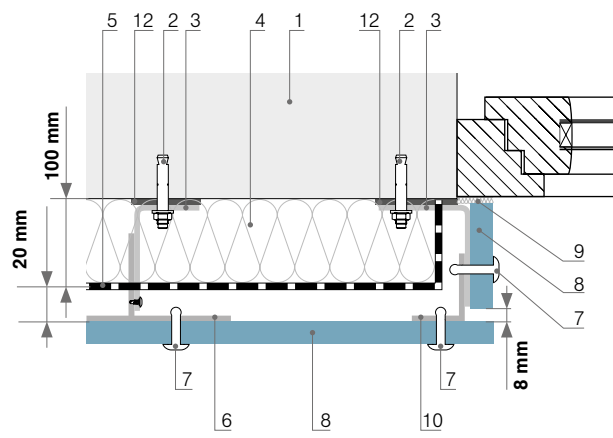

Fig. Draft C-C
Connector with window elements (internal)

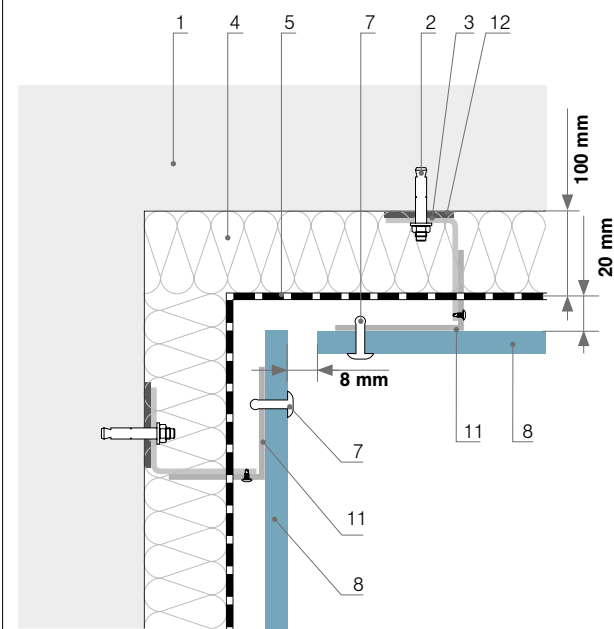

Fig. Draft H-H
Connector at the inner corner

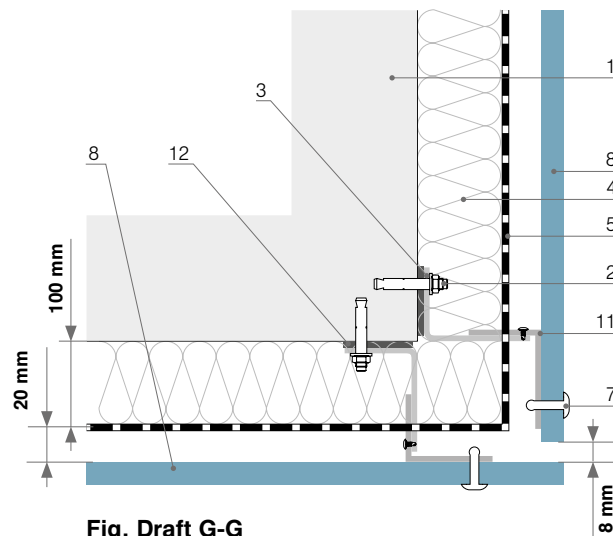
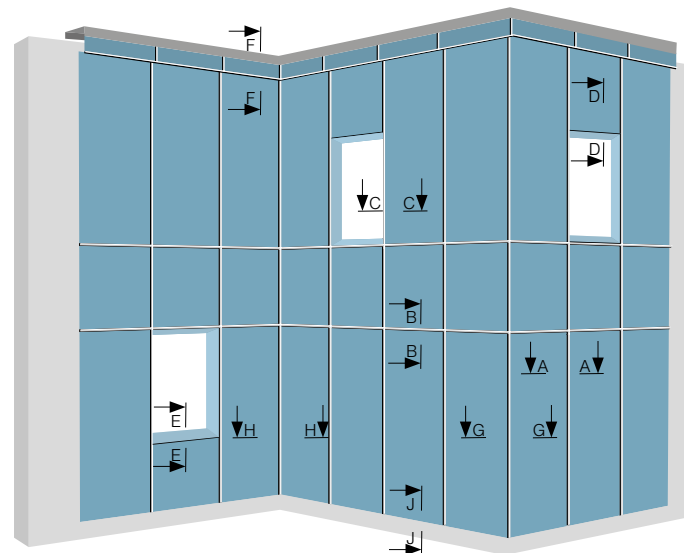

Fig. Draft G-G
Connector at the outer corner



vertical cross-section

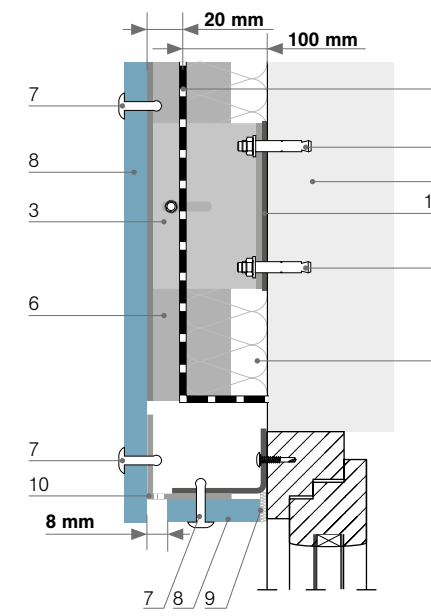

Fig. Draft D-D
Connector with window element (external)

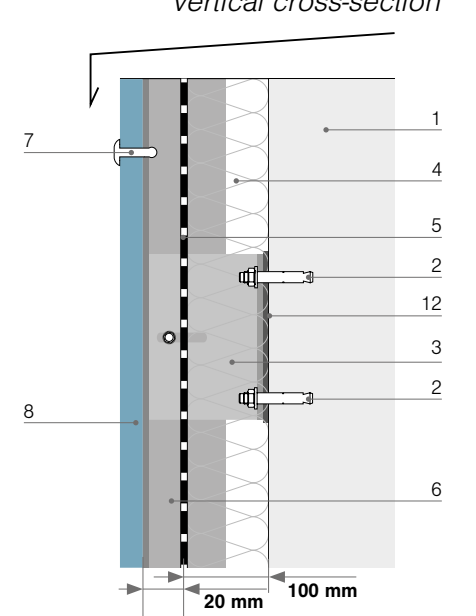

Fig. Draft F-F
Upper part of the wall with closing frame

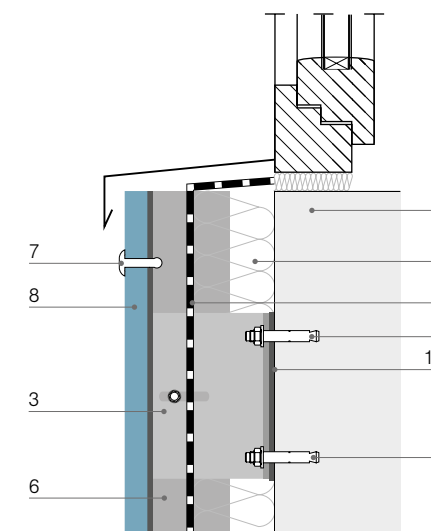

Fig. Draft E-E
External window sill

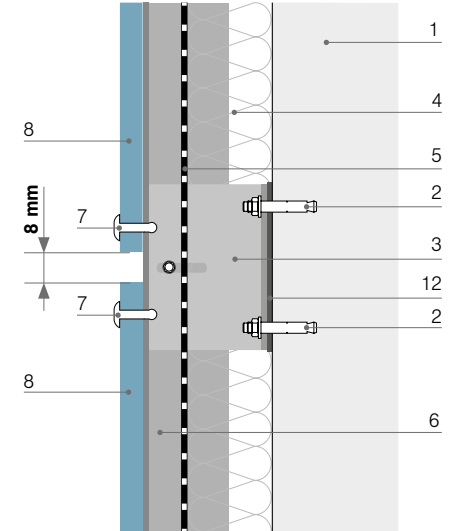

Fig. Draft B-B
Beam connector

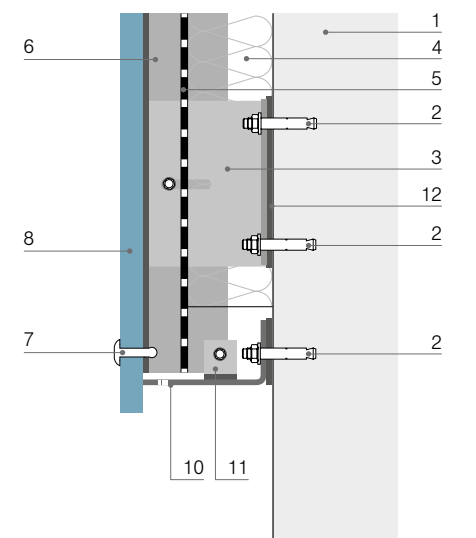

Fig. Draft J-J
Bottom part of the wall

1. Supporting wall
2. Fixing anchor
3. Fixing angle L120 x 60 x 3, length 60 mm
4. 100 mm mineral wool
5. Windproofing
6. T90 x 70 x 4 fixing tees
7. Rivet fastening in the color of the panel
8. Kronoart® panel
9. Weather silicone
10. Perforated angle
11. 40 x 40 angle
12. Insulation washer 80/50

Visible fixing on wooden substructure

horizontal cross-section

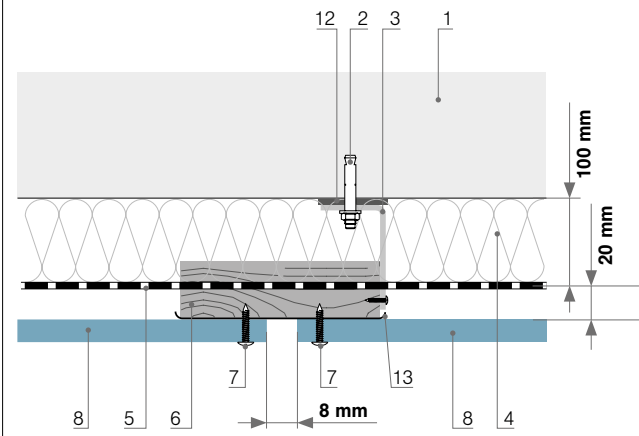

Fig. Draft A-A
I-Beam connector

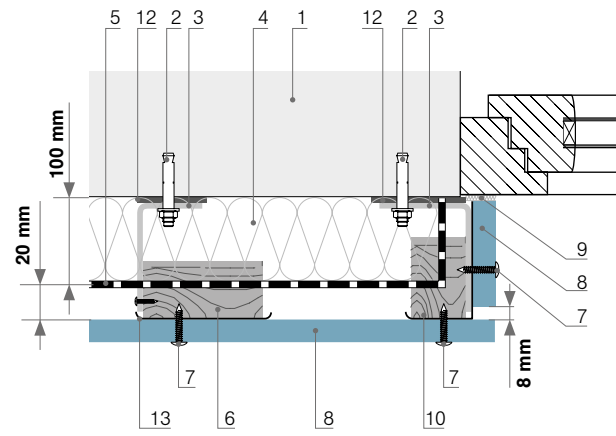

Fig. Draft C-C
Connector with window elements (internal)

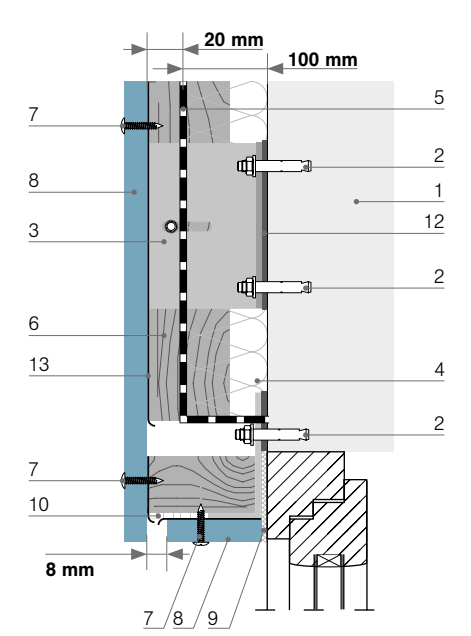

Fig. Draft D-D
Connector with window element (external)

vertical cross-section

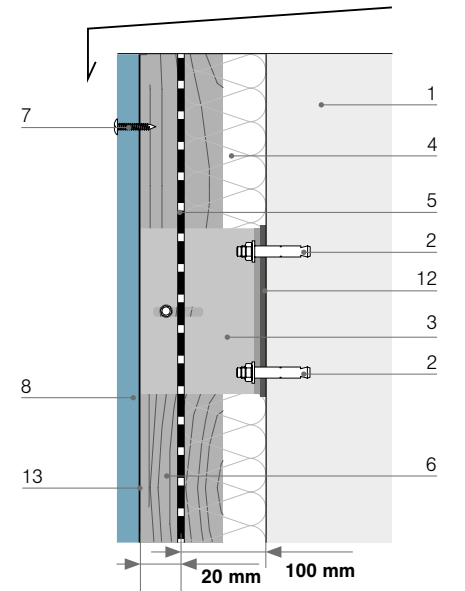

Fig. Draft F-F
Upper part of the wall with closing frame

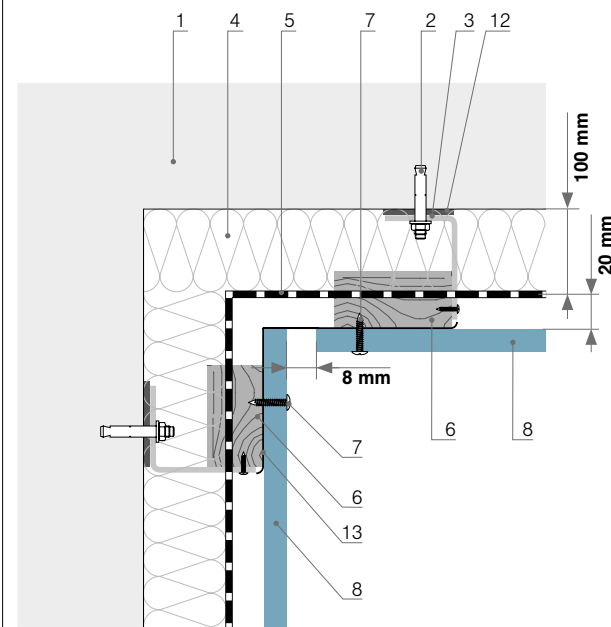

Fig. Draft H-H
Connector at the inner corner

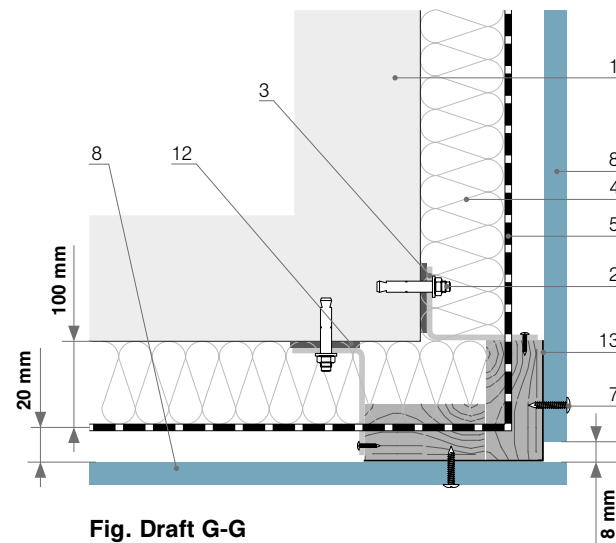

Fig. Draft G-G
Connector at the outer corner

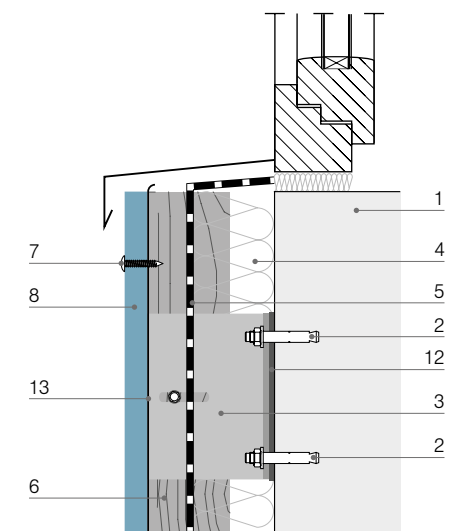

Fig. Draft E-E
External window sill

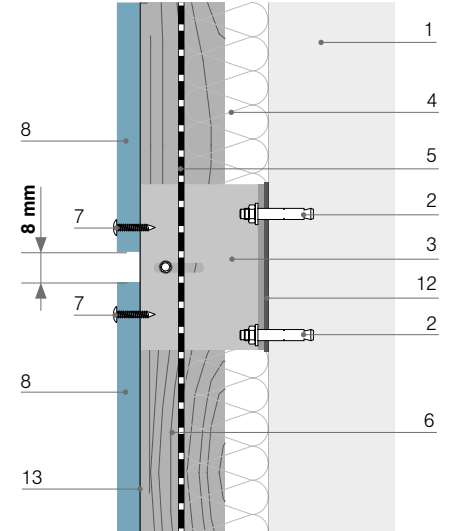

Fig. Draft B-B
Beam connector

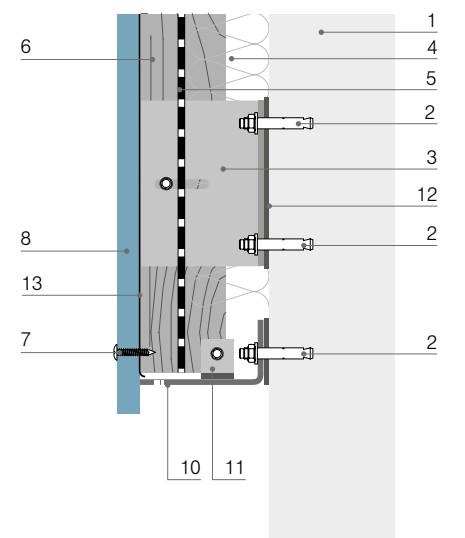
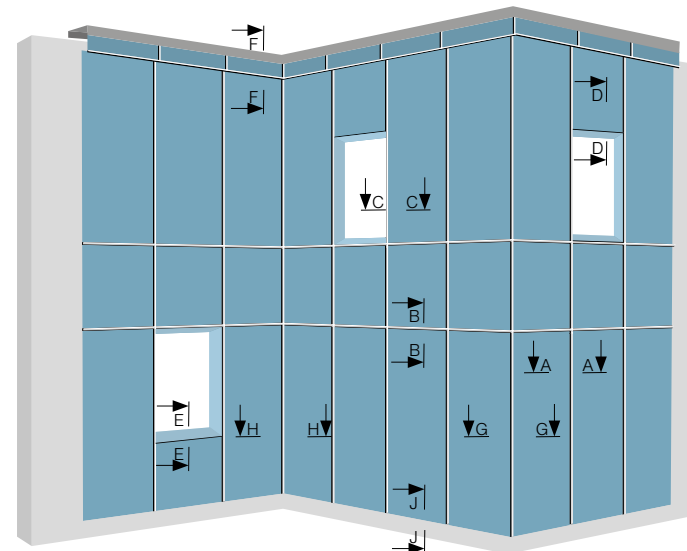

Fig. Draft J-J
Bottom part of the wall

1. Supporting wall
2. Fixing anchor
3. Fixing angle L120 x 60 x 3, length 60 mm
4. 100 mm mineral wool
5. Windproofing
6. Vertical timber batten
7. Rivet fastening in the color of the panel
8. Kronoart® panel
9. Weather silicone
10. Perforated angle
11. 40 x 40 angle
12. Insulation washer 80/50
13. EPDM tape

Visible fixing on timber frame buildings

horizontal cross-section

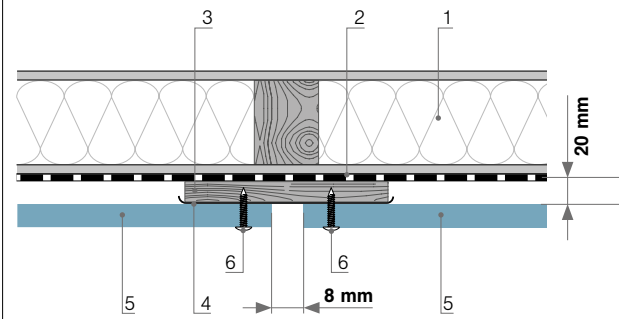

Fig. Draft A-A
I-Beam connector

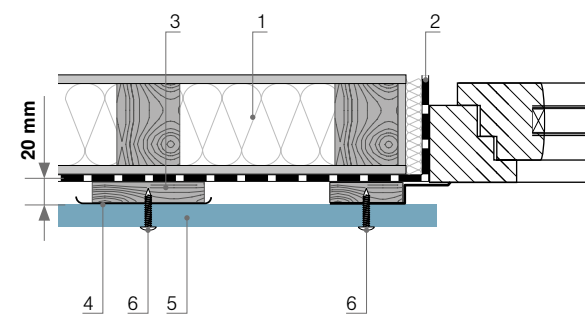

Fig. Draft C-C
Connector with window elements (internal)

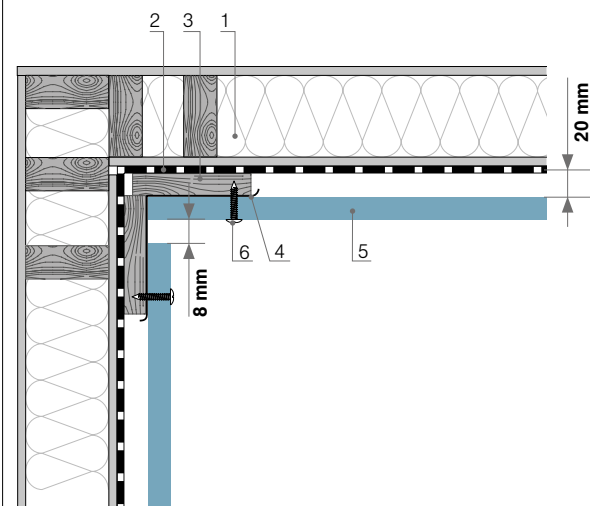

Fig. Draft H-H
Connector at the inner corner

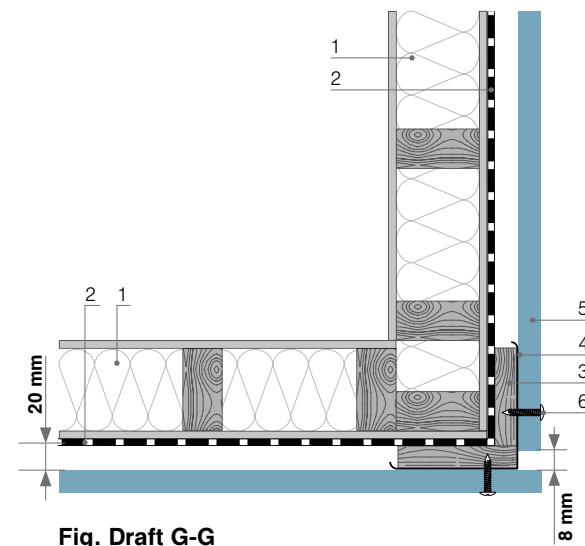
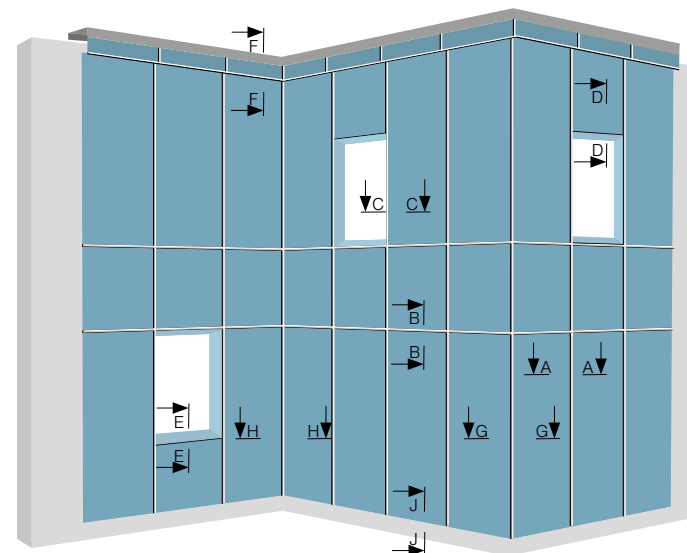

Fig. Draft G-G
Connector at the outer corner



vertical cross-section

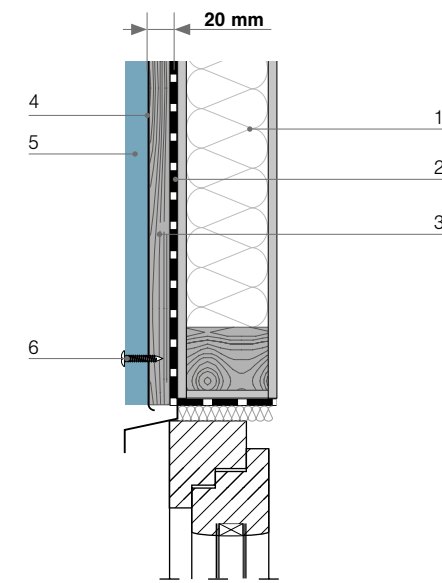

Fig. Draft D-D
Connector with window element (external)

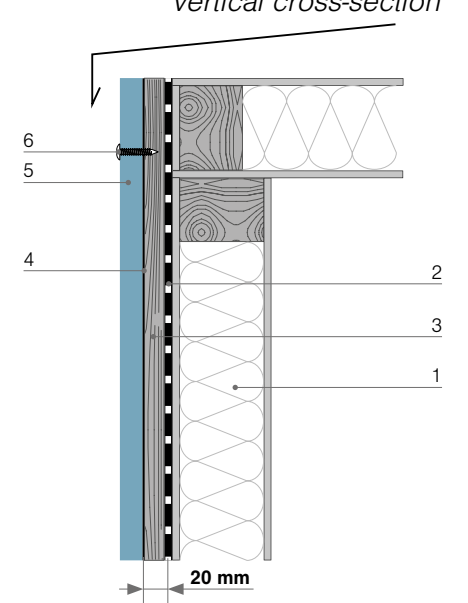

Fig. Draft F-F
Upper part of the wall with closing frame

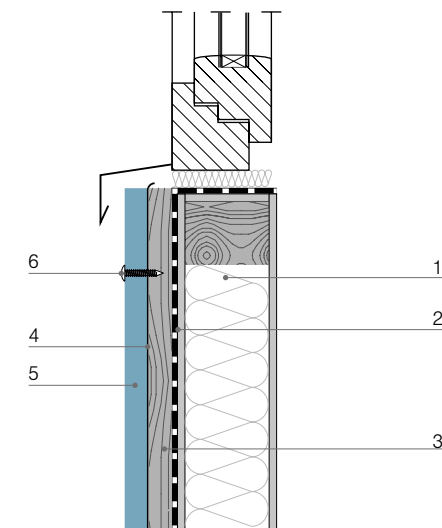

Fig. Draft E-E
External window sill

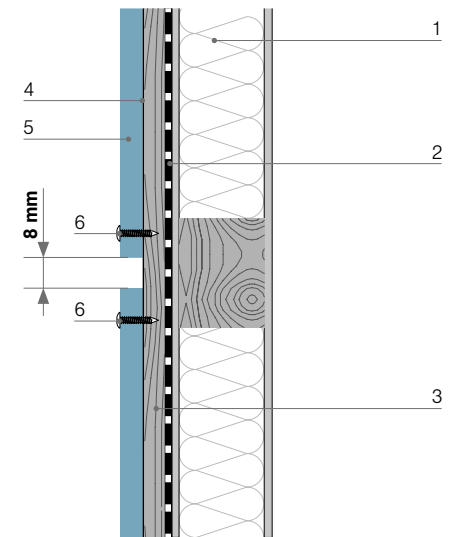

Fig. Draft B-B
Beam connector

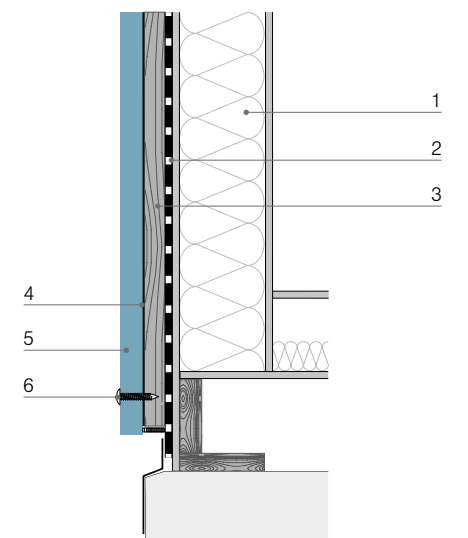

Fig. Draft J-J
Bottom part of the wall

1. Load bearing wall
2. Windproofing
3. Vertical timber batten
4. EPDM tape
5. Kronoart® panel
6. Rivet fastening in the color of the panel

Installation via concealed fittings

General information

Hidden mechanical fixing offers the advantage of delivering stronger, more uniformly distributed fixing forces. They achieve durable mounting, and optimize bonding with the substrate without expansion stresses.

Thickness of panels

The ideal thickness is 10 mm, although as a minimum, 8 mm panels may be used. This is due to the perforation and method of fixing.

Recommendations for installation

The length of lateral edge for every format should not exceed 3050 mm.

Spacing of fixing holes

Follow the guidelines below to select the correct spacing for fixing holes. The centers recommended relate to one-span installation of panels.

	Thickness [mm]	max. B, D [mm]	max. d [mm]	max. b [mm]
One-span fixing				
	10	740	125	150

Tab. Distribution of holes - one-span installation

In the case of multi-span fixing of panel, it is recommended to distribute the installation holes as given in the table below.

	Thickness [mm]	max. B, D [mm]	max. d [mm]	max. b [mm]
Multi-span fixing				
	8	740	20 - 80	20 - 60
	10	800	20 - 100	20 - 80

Tab. Distribution of holes - multi-span installation

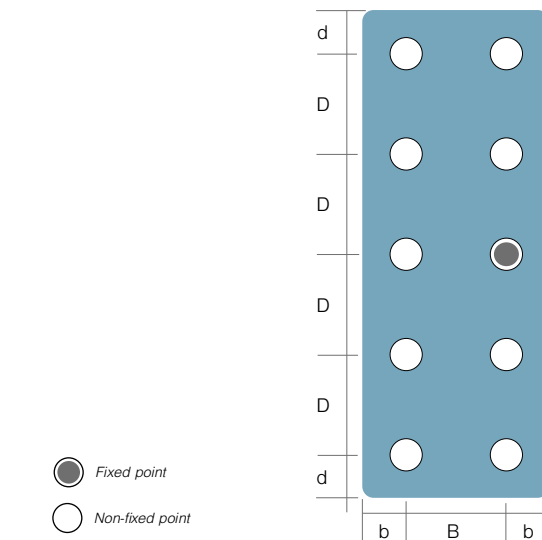
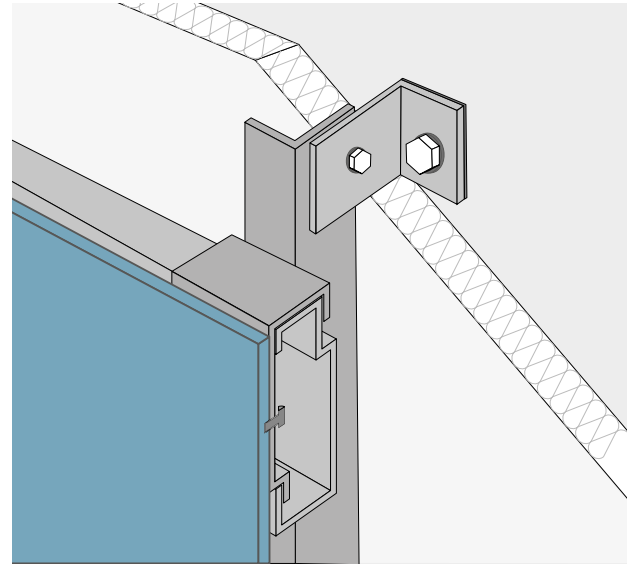

Fig. One-span fixing

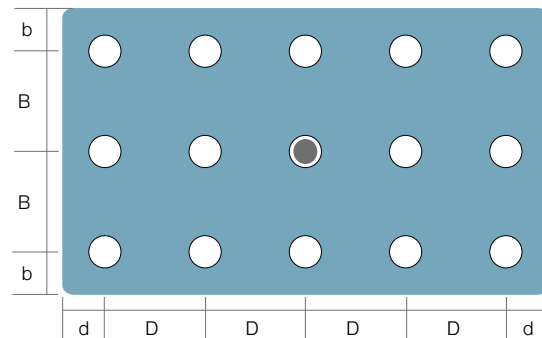

Fig. Multi-span fixing

Concealed fittings techniques

There are two options available:

- Vertical bearing elements fitted to the substrate which give a flat uniform installation surface.
- Horizontal elements fixed to the load bearing verticals. Special hanging connectors (hangers, safety pins and clips) are utilized.

Fasteners such as screws, studs and clinch bolts are selected depending on the type and thickness of the panels, and the expected environmental conditions of the location.

Correctly installed according to guidelines, the construction should guarantee stress-free installation and weather resistance.

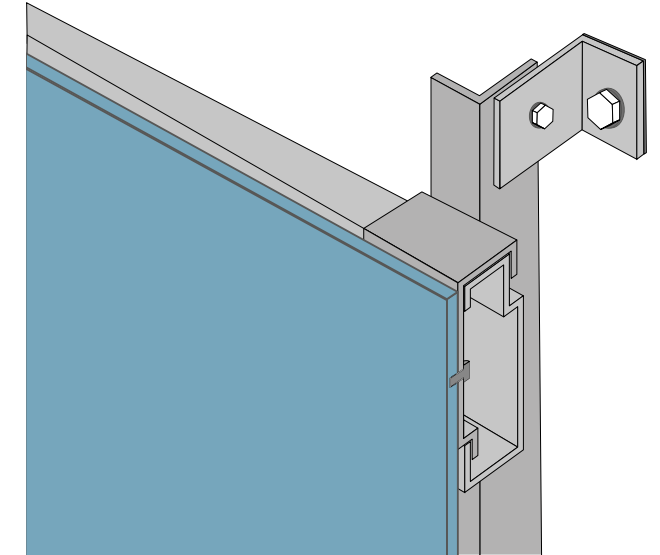

Fitting connectors

Connector KEIL

Basic connector consists of a sleeve and a locking screw.

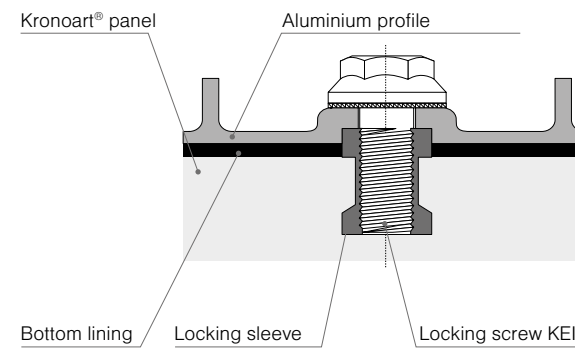

- D₁ Hole diameter (≥ 7 mm)
- D₂ Undercut diameter (≥ 9 mm)
- H Panel thickness (≥ 8 mm)
- H_s Anchorage depth
- X_A Bolt height (3 mm)
- X_Z Aluminium profile thickness in the structure

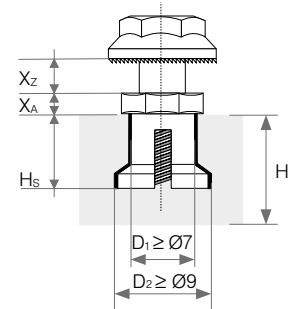

Connector SFS

The sleeve is made from austenitic stainless steel (AISI 316, grade 1.4401 acc. to PN-EN), whereas the stem is from carbon steel (stem is completely removed during setting).

Type	Material S = steel	Ø	L	Panel thickness	Thickness of joined elements
TUF-	S-	6.0x	9	8	2.5 - 3.5
				10 - 13	0.5 - 3.5
TUF-	S-	6.0x	11	8	4.5 - 5.5
				13	0.5 - 5.5
TUF-	S-	6.0x	13	10	4.5 - 7.5
				13	2.5 - 7.5

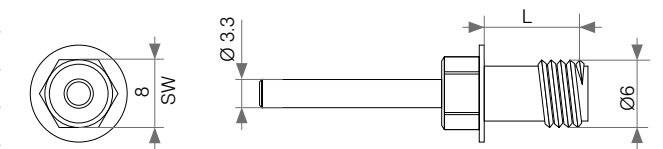

Fig. Clinch bolt TU-S6.0x9 - Construction and dimensions (mm).

Fig. Dimensions and designations of connectors (all dimensions in mm)

Invisible fixing on metal substructure

horizontal cross-section

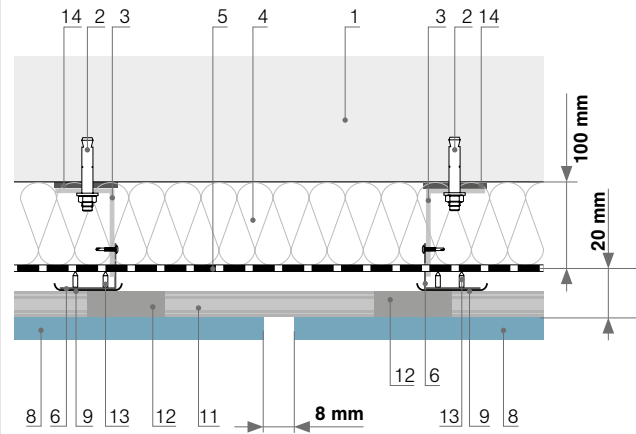

Fig. Draft A-A
I-Beam connector

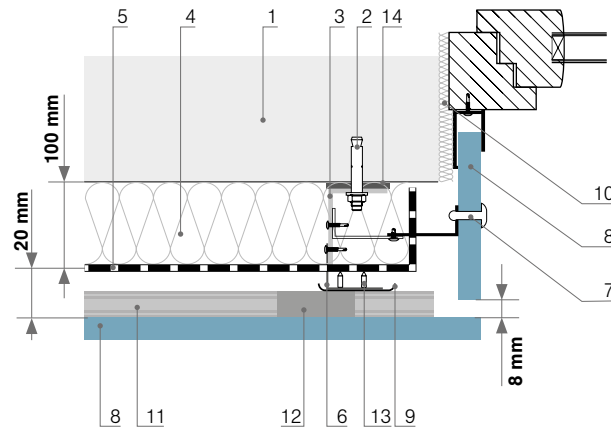

Fig. Draft C-C
Connector with window elements (internal)

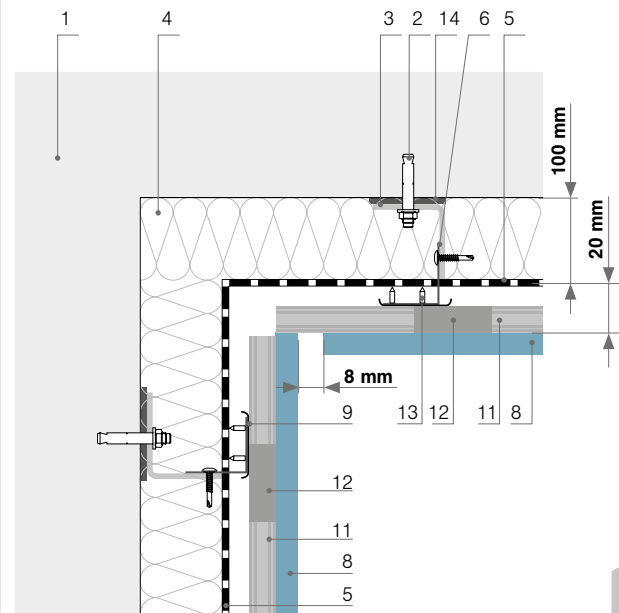

Fig. Draft H-H
Connector at the inner corner

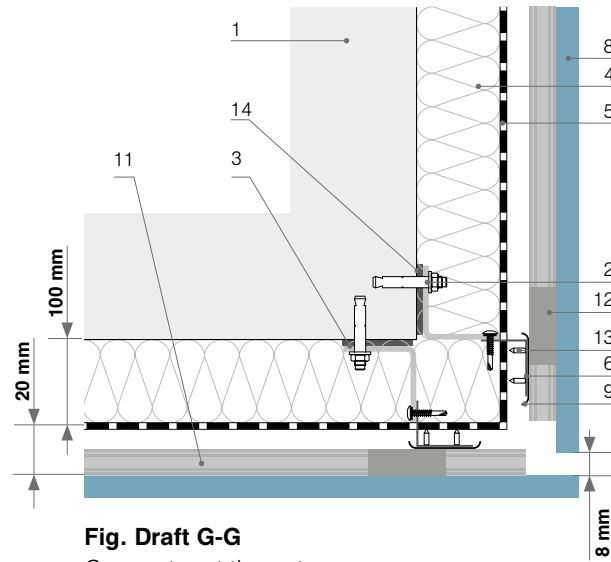

Fig. Draft G-G
Connector at the outer corner

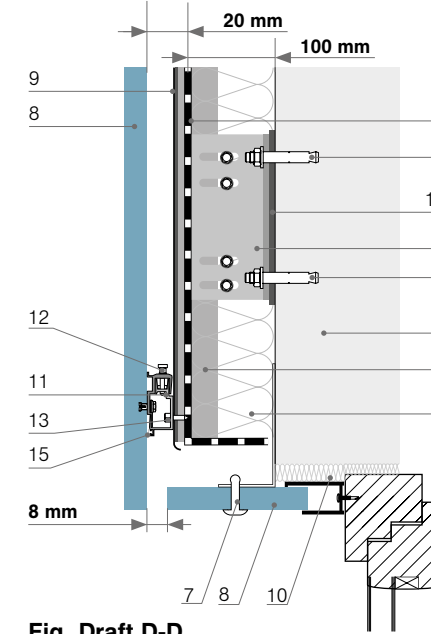
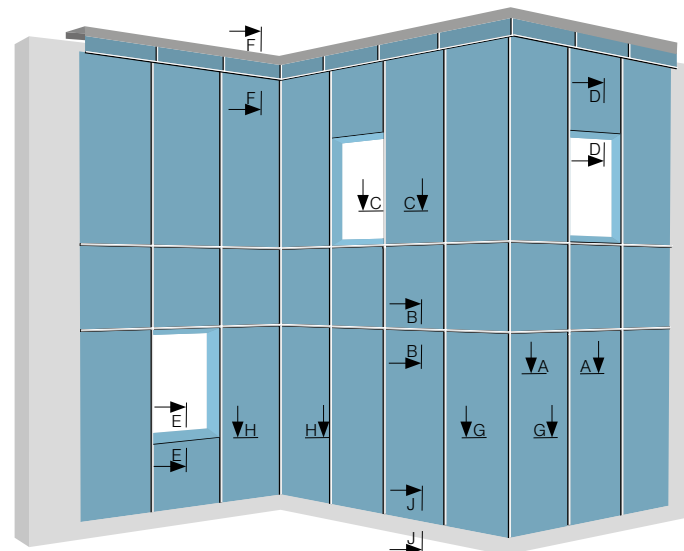

Fig. Draft D-D
Connector with window element (external)

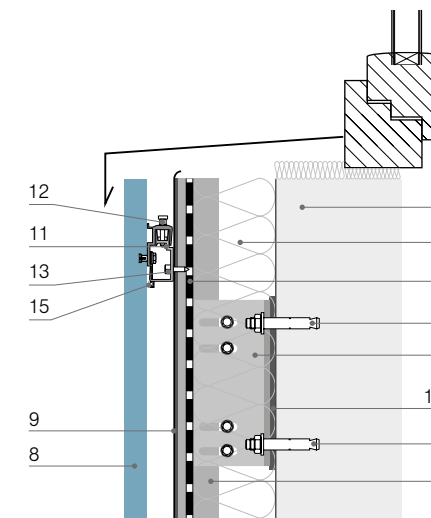

Fig. Draft E-E
External window sill

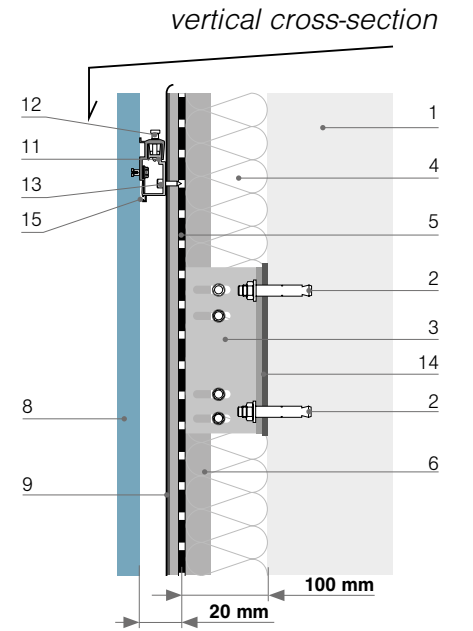

Fig. Draft F-F
Upper part of the wall with closing frame

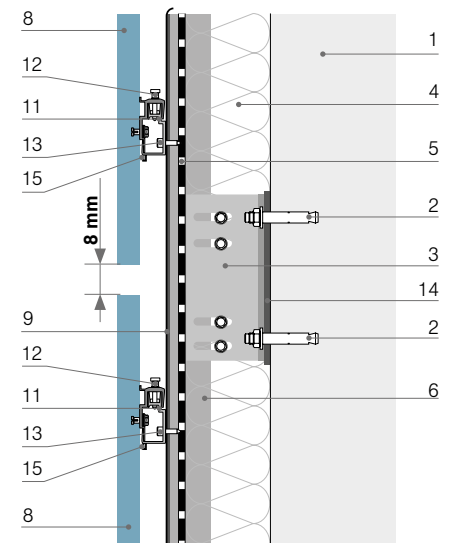

Fig. Draft B-B
Beam connector

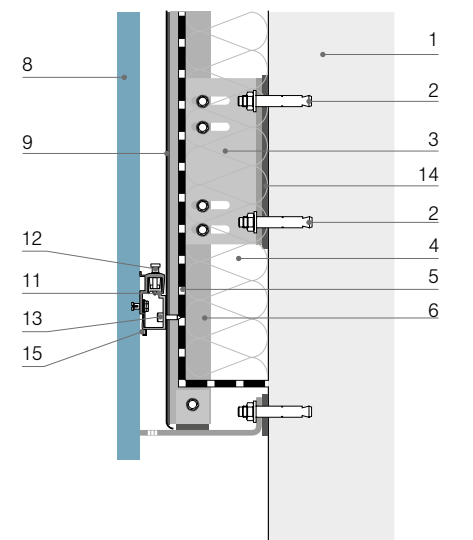

Fig. Draft J-J
Bottom part of the wall

1. Supporting wall
2. Fixing anchor
3. Double aluminium console
4. 100 mm mineral wool
5. Windproofing
6. Facade profile L - 60x45
7. Rivet fastening in the color of the panel
8. Kronoart® panel
9. EPDM tape
10. Weather silicone
11. Facade profile of the invisible assembly system
12. Regulation clip for invisible INV-system round hole assembly
13. Screws 4.8 x 19 A2
14. Insulation washer 80/50
15. Rubber for INV-system profile

Installation through adhesive

General information

PanelTack is a moisture curing, highly elastic adhesive based on SMP (Silyl Modified Polymer). PanelTack is solvent- and isocyanate free.

Product advantages

- Reliable blind fixing method
- Simple and fast installation
- Optimal tension distribution

Application

Bonding of panels for:

- Facade cladding.
- Fascias and soffits.
- Ceilings, canopies, awnings.
- Wall covering panels in a.o. porches.

Features PanelTack bonding system

- Durable and highly elastic with an optimal tension distribution.
- Suitable for the bonding of larger panels up to panels.
- Excellent mechanical strength.
- Good moisture- and weather resistance.
- Quick and easy mounting.

Bostik bonding system consists of:

PanelTack	highly elastic adhesive
Primer Paneltack	for pre-treatment of the bonding side of the cladding panel.
Primer Paneltack	primer for metal support construction
Foam tape 12 x 3 mm	for the initial bonding of the panels and a spacer to obtain a sufficient thick adhesive layer.

Reaction to fire

Within Europe wall cladding constructions should comply to class D according to EN 13501-1.

As demands and requirements in other countries may differ we advise to consult local authoritative test institutes for detailed information.

Maximum panel size

PanelTack is highly elastic, therefore possible deformations of the Kronoart® panels can be absorbed in the adhesive layer. When mounting Kronoart® panels a maximal occurring displacement of 2.5 mm/m¹ has to be taken into account. The maximal elastic deformation which the PanelTack system practically still can absorb, may not exceed 4.3 mm. This means that the maximal diagonal length of the panels may not exceed 3440 mm. Panels must be evenly flat prior to bonding. In this aspect large panels are more critical than small panels, therefore extra care regarding correct handling and storage is inevitable.

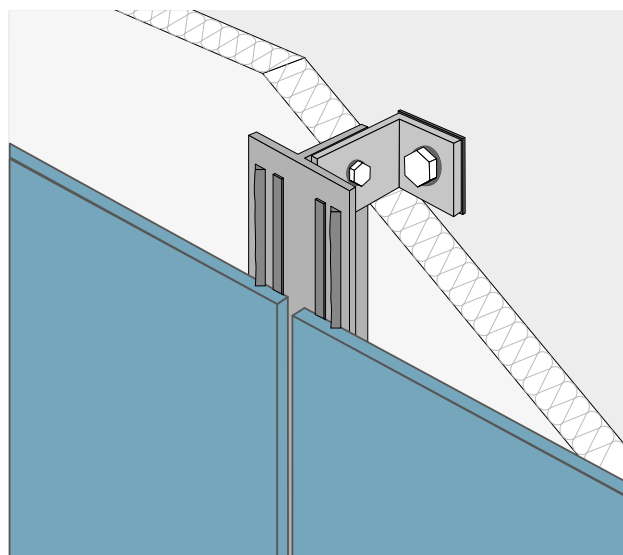

Fig. Invisible fixing on metal substructure

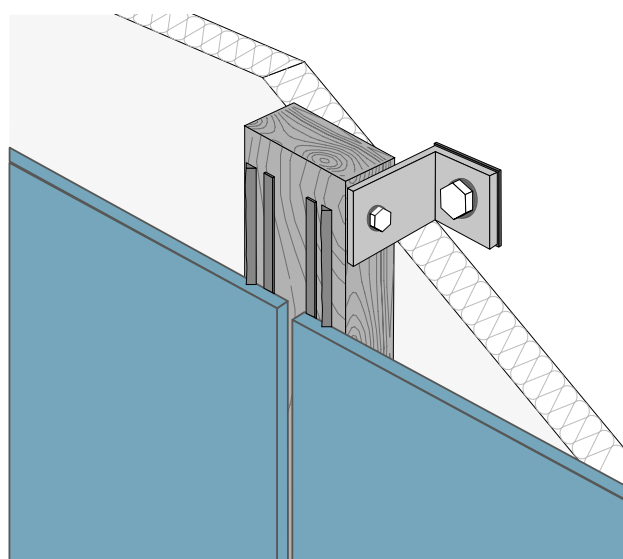

Fig. Invisible fixing on wooden substructure

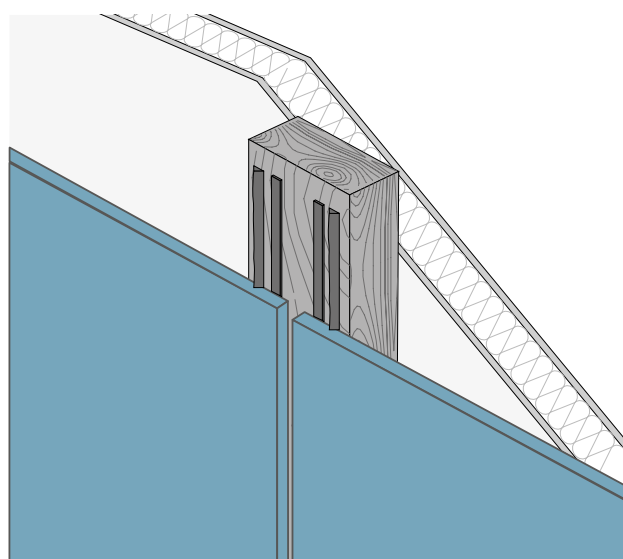

Fig. Invisible fixing on timber frame buildings

Support construction

Choice of material

Dry and smooth (galvanized) steel or (anodized) aluminium. These metals must be rustproof and after fixing they must conform to relevant standards. Enamelled metals are suitable as well, however different instructions for use may apply.

Ventilation

The support battens or profiles must only be mounted vertically. Behind the panels there has to be an open ventilated cavity of minimal 20 mm. Furthermore ventilation openings/slots of at least 50 cm²/m¹ at both the top and the bottom of the bonded panels. For horizontal applications preferably apply the battens perpendicular to the facade in order to ventilate over the short end.

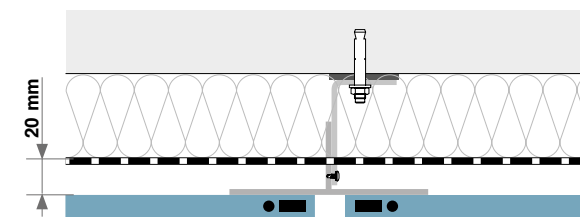

Minimal joint width

A joint between the panels with a width of min. 8 mm is recommended.

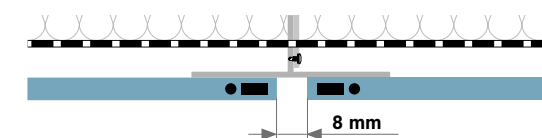

Dimensions and distances

The minimal widths of supports in the support construction depend on the function of the supports:

- support for joints – aluminium – 100 mm
- end-and intermediate support – aluminium – 40 mm

The distances between the support battens or profiles as indicated by the panel manufacturer.

Panel thickness [mm]	6	8	10
2 fixings in one direction	440	590	640
3 or more in one direction	540	640	640

For horizontal applications (ceilings) these distances must be multiplied with 3/4.

Consumption per 100 m² surface panel

Foam tape 12 25 metre role
 Paneltack 50 290 ml cartridge
 Primer Paneltack (panel) 3 500 ml tin
 Primer Paneltack (metal) 3 500 ml tin

Application conditions

The cladding panels can be bonded indoors (in a factory) or on the building site.

The following conditions apply:

- Do not pre-treat or bond in case of rain.
- Do not pre-treat or bond in case of very high air humidity for instance during dense fog.
- Avoid condensation on both the panels and support construction: the dew point must be 3 °C above substrate temperature.
- Apply between +5 °C and +30 °C.

Prevent warping of the panels due to the influence of moisture.

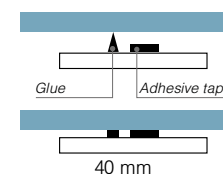
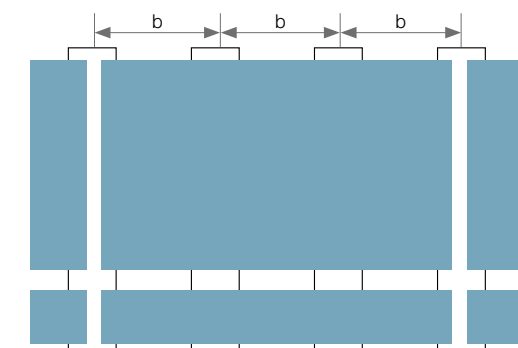

Multispan example

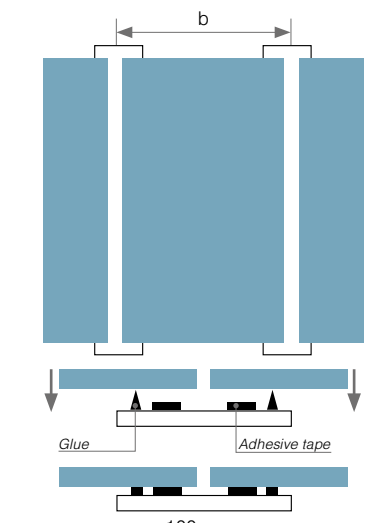

Single span example

Installation instructions

Pre-treatment support construction

The support construction must be primed before or after mounting. The primer can be applied both in and outdoors. Use Primer SX Black for wood and Primer PanelTack for metal. One (continuous and closed) coat of primer is sufficient. Residues of primer should not be used. Avoid contamination of the support construction with dust and grease after application of primers. Metal support construction: Apply Primer PanelTack straight from the tin on a clean, lint free and pigment free cloth or tissue paper. Firmly rub the supports with the primer-soaked cloth. Minimal drying time after application 10 minutes. Replace cloths regularly by new ones. Do not treat more surface than can be bonded within 6 hours.

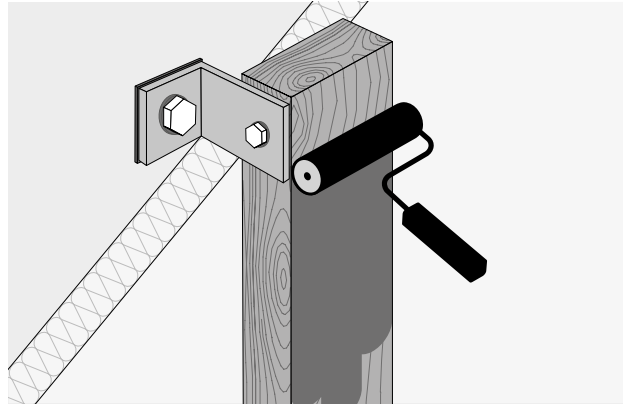

Pre-treatment cladding panel

Apply Primer PanelTack straight from the tin on a clean, lint free and pigment free cloth or tissue paper. Firmly rub the supports with the primer-soaked cloth. Minimal drying time after application 10 minutes. Replace cloths regularly by new ones. Do not treat more surface than can be bonded within 6 hours.

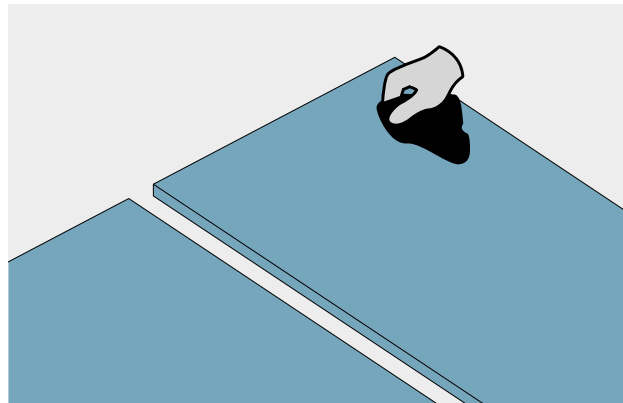

Application of foam tape

Once the primers have dried, foam tape is applied only vertically to the support construction without any interruption. Press foam tape firmly onto the support construction and cut it with a sharp knife. When deciding on the correct position and length of the tape also bear in mind the dimensions of the supports, the dimensions of the panels and the necessary space for the adhesive. Do not immediately remove the protective layer after application of the foam tape.

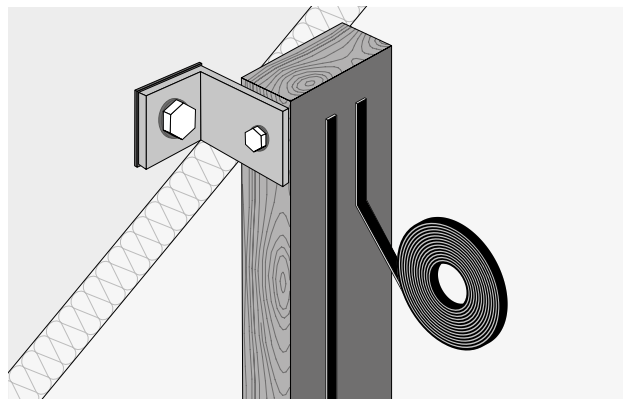

Application of adhesive with special nozzle

Apply PanelTack only vertically and without interruption after the application of the foam tape. Use a hand- or an air pressure caulking gun. A special V-shaped nozzle has been packed with every cartridge PanelTack. This enables to apply a triangular adhesive bead with a width and height of 9 mm. Using this special nozzle prevents the enclosure of air bubbles and unnecessary loss of adhesive. Opposite the V-cut one can cut the nozzle obliquely.

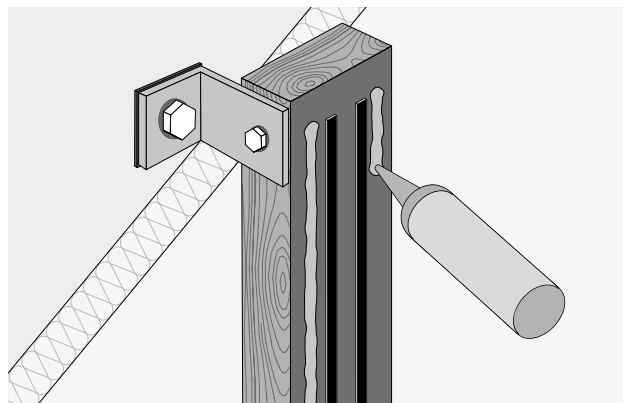

Placing the panel

Now remove the protective layer from the foam tape. Apply the cladding panel within 10 minutes of adhesive application. Fix the panel by gently pressing it onto the adhesive beads and, if necessary, correct its position. Correction is still possible until the panel touches the foam tape. For accurate, easier positioning of the panel use a joint spacer, supporting blocks or horizontal supporting rails. For easier handling a glass suction clamp can be useful. Once the panel is positioned correctly, the panel must be pressed down by gently rubbing over the entire length of the foam tape. Avoid pressing the foam tape together. At this stage it's no longer possible to correct the panel position. See the detail drawings.

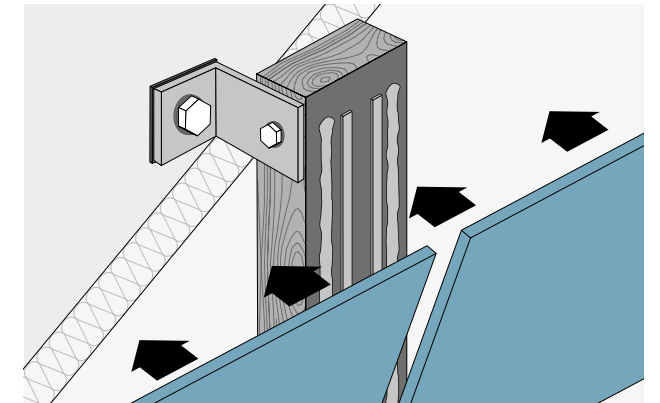
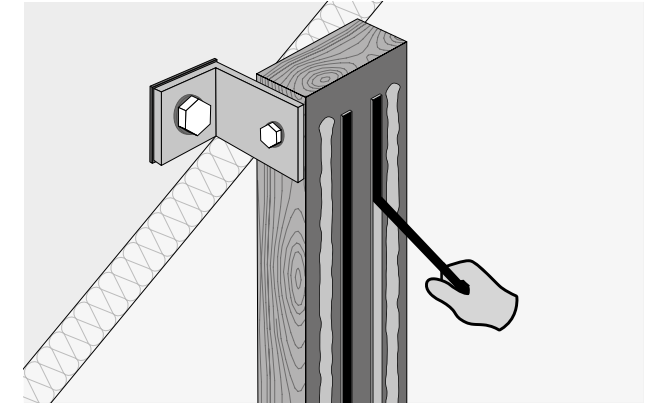

Cleaning

Avoid contamination of the front side of the panels with primer or adhesive. Uncured primer or uncured adhesive residues can be removed with a suitable cleaner such as Liquid 1. Use a clean, lint free and pigment free cloth or tissue paper. Test first on a small unobtrusive area to check that the cleaner does not attack or contaminate the panel.

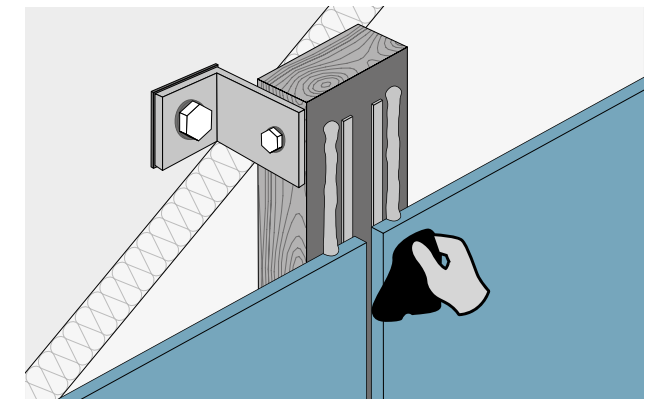

Removing the protective foil from the front face

Immediately after bonding, if the protective foil is still present, it should be removed from the front face of the panel.

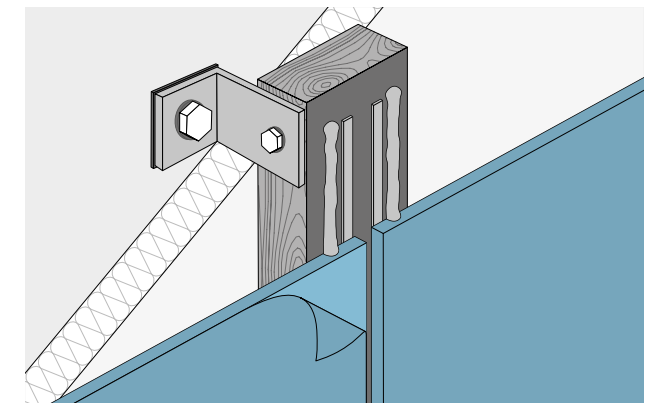

Invisible fixing on metal substructure

horizontal cross-section

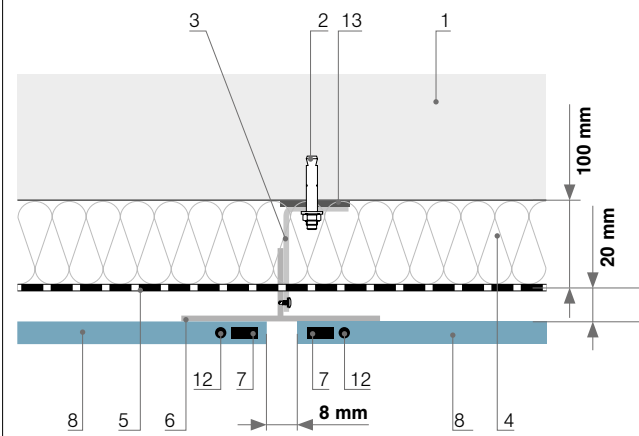

Fig. Draft A-A
I-Beam connector

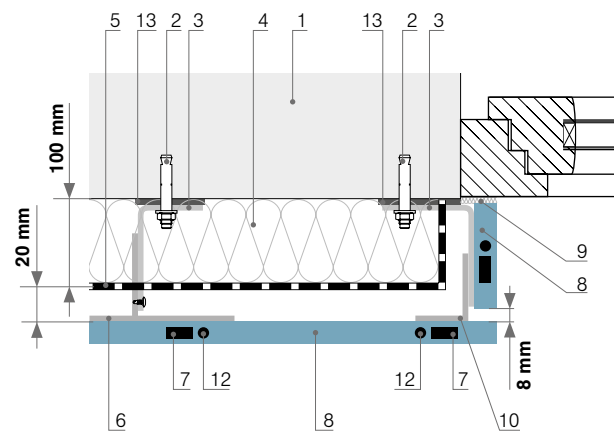

Fig. Draft C-C
Connector with window elements (internal)

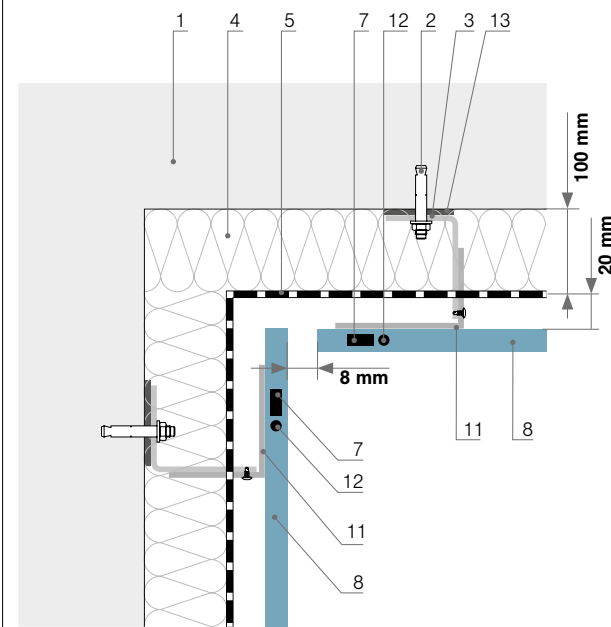

Fig. Draft H-H
Connector at the inner corner

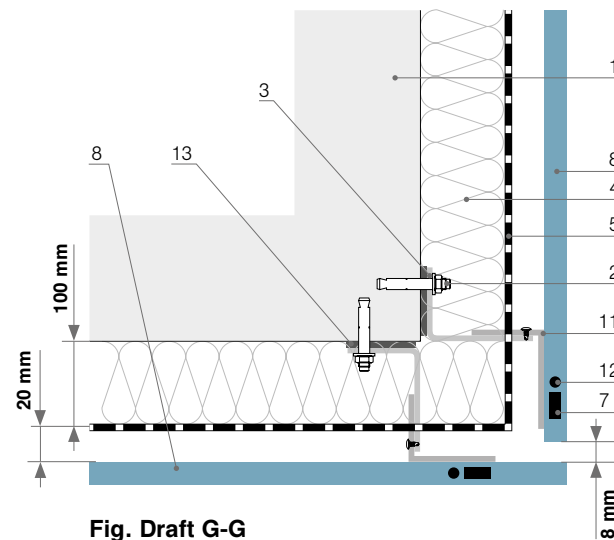

Fig. Draft G-G
Connector at the outer corner

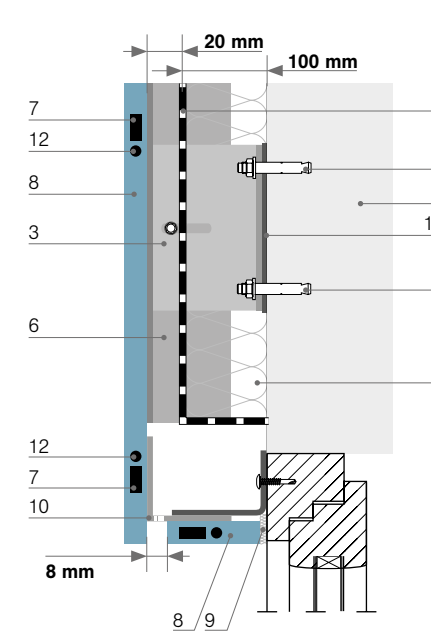
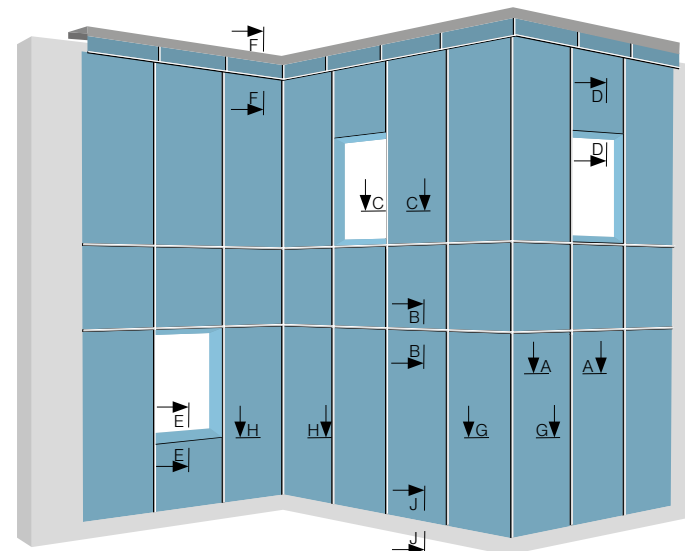

Fig. Draft D-D
Connector with window element (external)

vertical cross-section

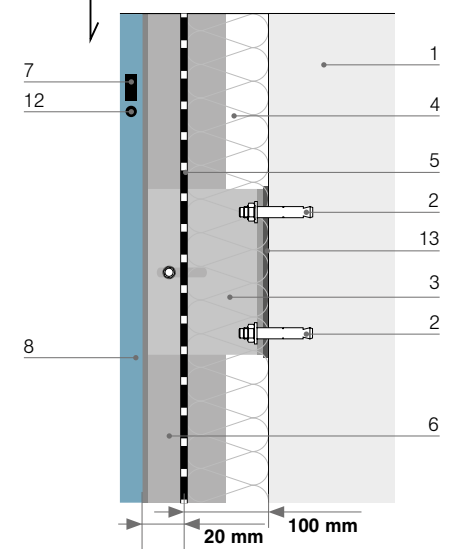

Fig. Draft F-F
Upper part of the wall with closing frame

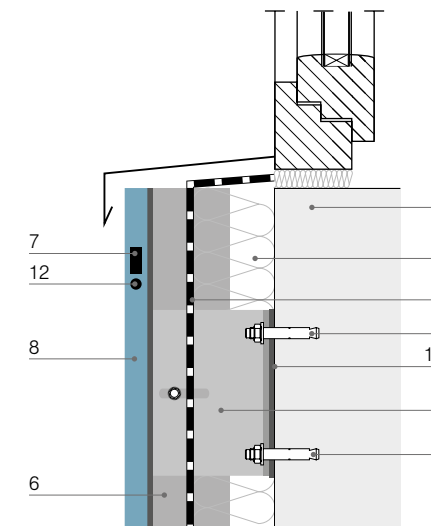

Fig. Draft E-E
External window sill

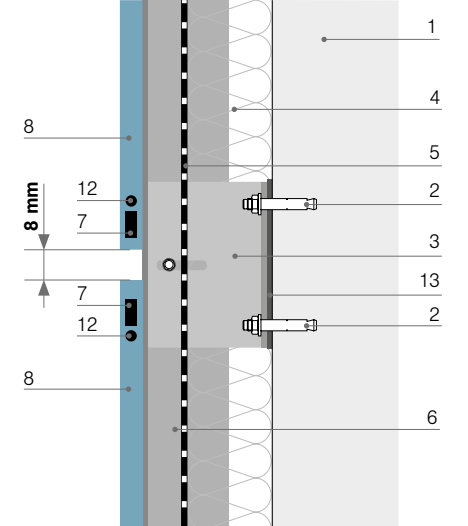

Fig. Draft B-B
Beam connector

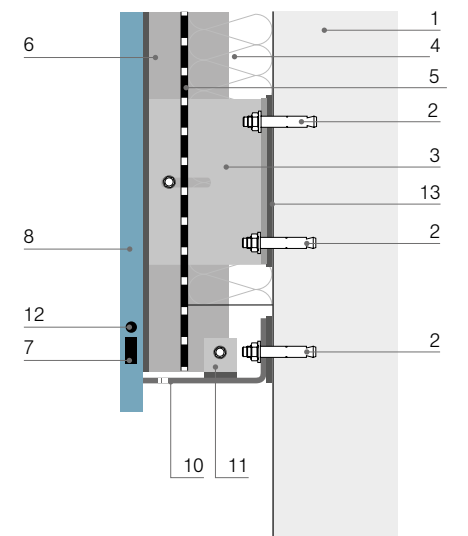

Fig. Draft J-J
Bottom part of the wall

1. Supporting wall
2. Fixing anchor
3. Fixing angle L120 x 60 x 3, length 60 mm
4. 100 mm mineral wool
5. Windproofing
6. T90 x 70 x 4 fixing tees
7. Foam tape
8. Kronoart® panels
9. Weather silicone
10. Perforated angle
11. 40 x 40 x 3 angle
12. Adhesive
13. Insulation washer 80/50

Invisible fixing on wooden substructure

horizontal cross-section

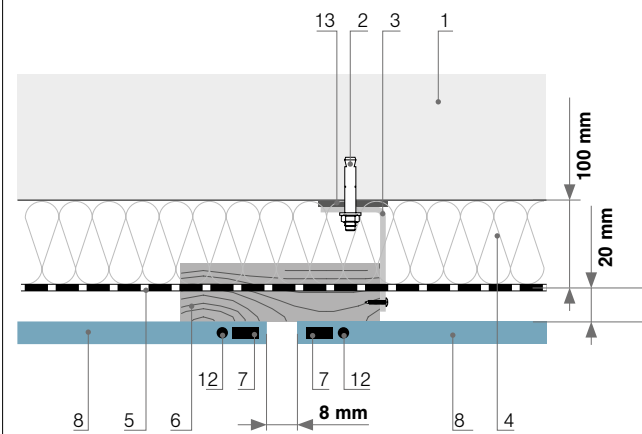

Fig. Draft A-A
I-Beam connector

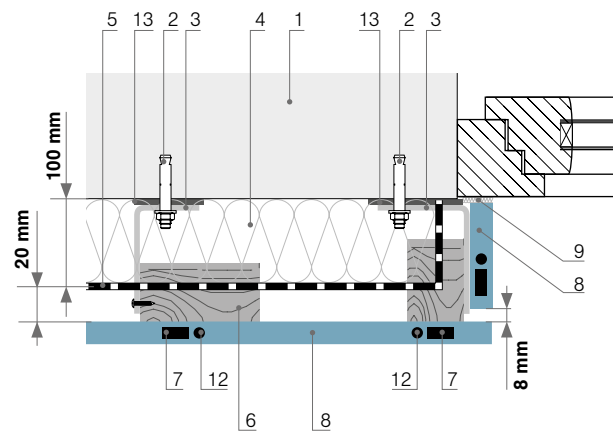

Fig. Draft C-C
Connector with window elements (internal)

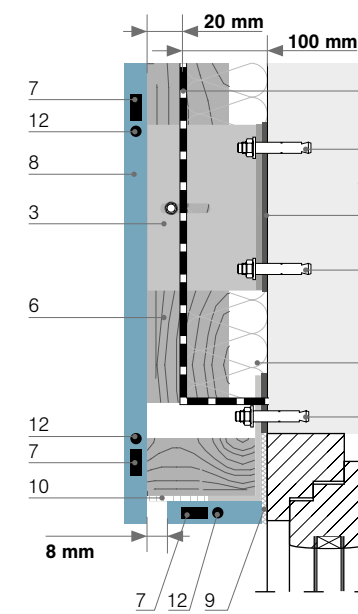

Fig. Draft D-D
Connector with window element (external)

vertical cross-section

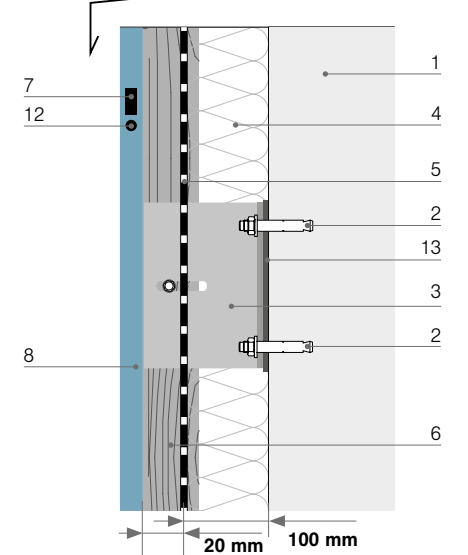

Fig. Draft F-F
Upper part of the wall with closing frame

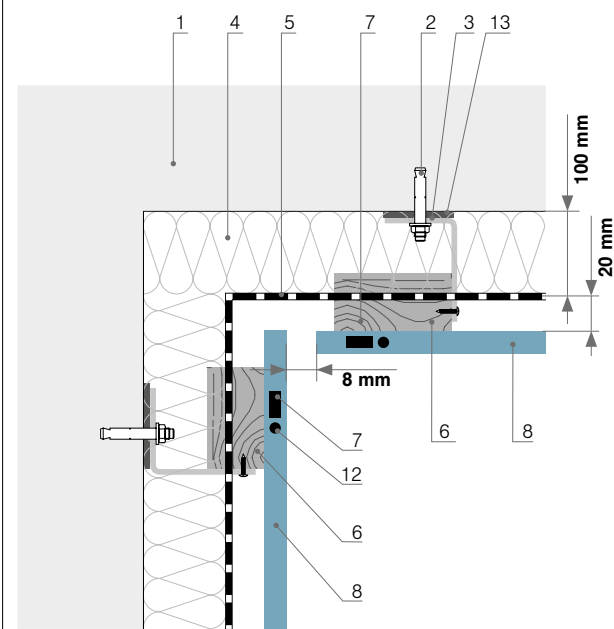

Fig. Draft H-H
Connector at the inner corner

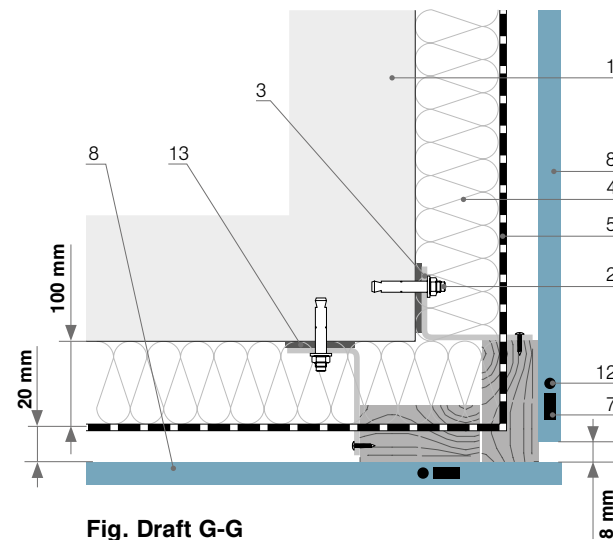

Fig. Draft G-G
Connector at the outer corner

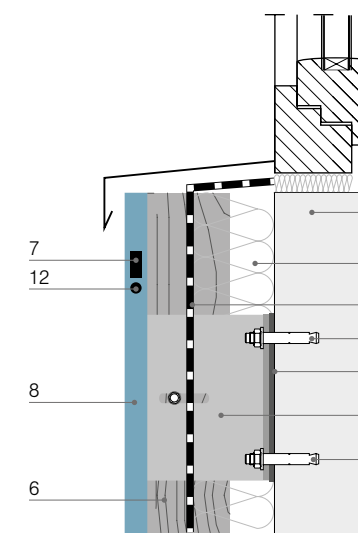

Fig. Draft E-E
External window sill

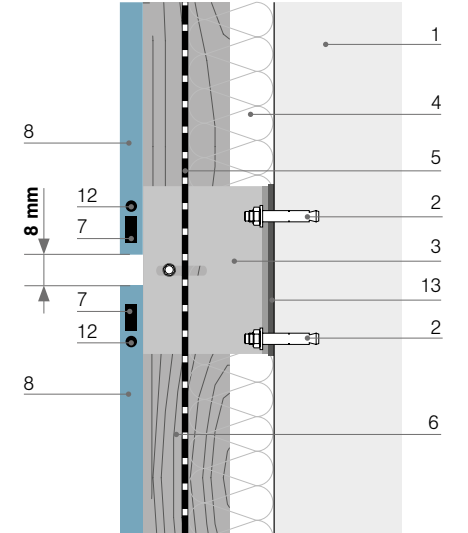

Fig. Draft B-B
Beam connector

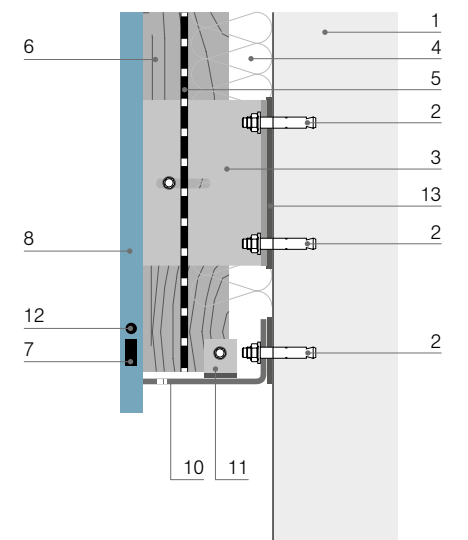
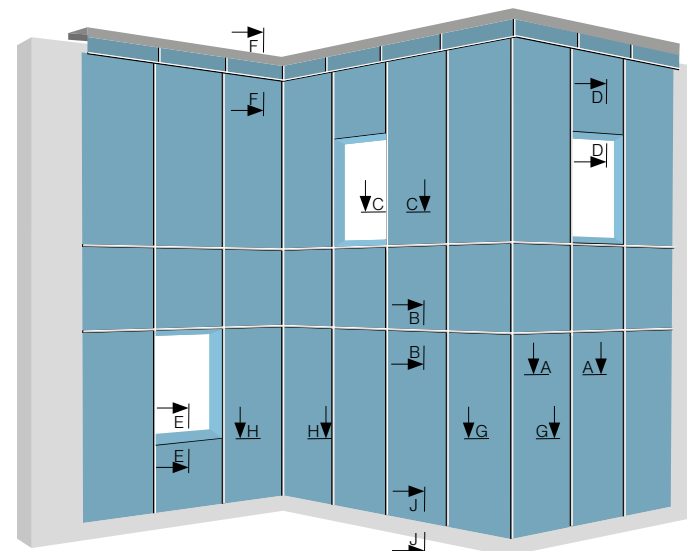

Fig. Draft J-J
Bottom part of the wall

1. Supporting wall
2. Fixing anchor
3. Fixing angle L120 x 60 x 3, length 60 mm
4. 100 mm mineral wool
5. Windproofing
6. Vertical timber batten
7. Foam tape
8. Kronoart® panels
9. Weather silicone
10. Perforated angle
11. 40 x 40 x 3 angle
12. Adhesive
13. Insulation washer 80/50

Invisible fixing on timber frame buildings

horizontal cross-section

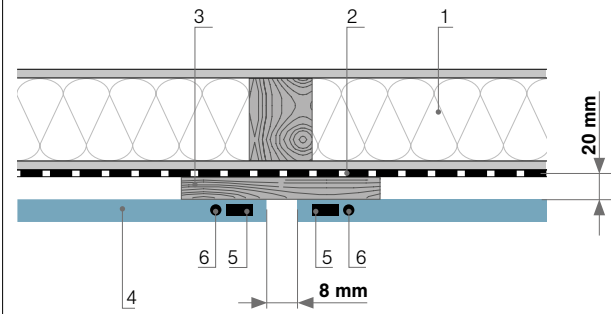

Fig. Draft A-A
I-Beam connector

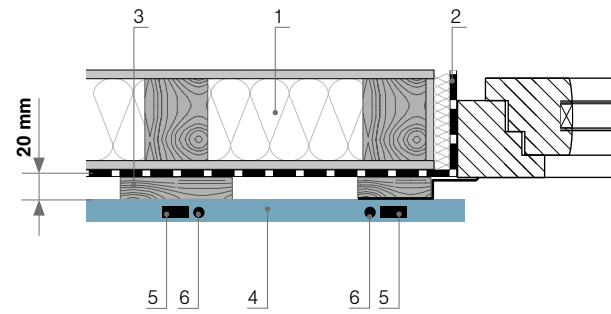

Fig. Draft C-C
Connector with window elements (internal)

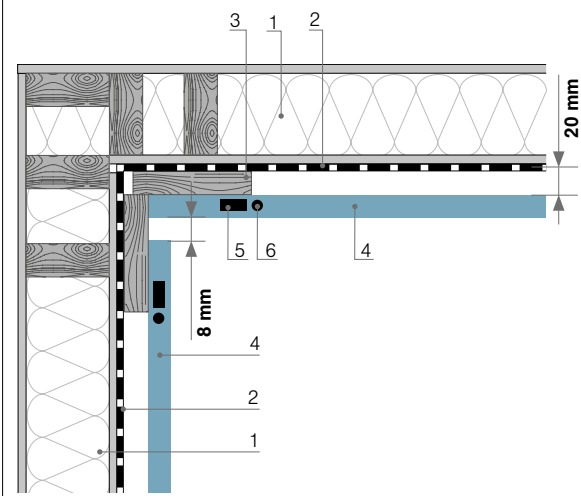

Fig. Draft H-H
Connector at the inner corner

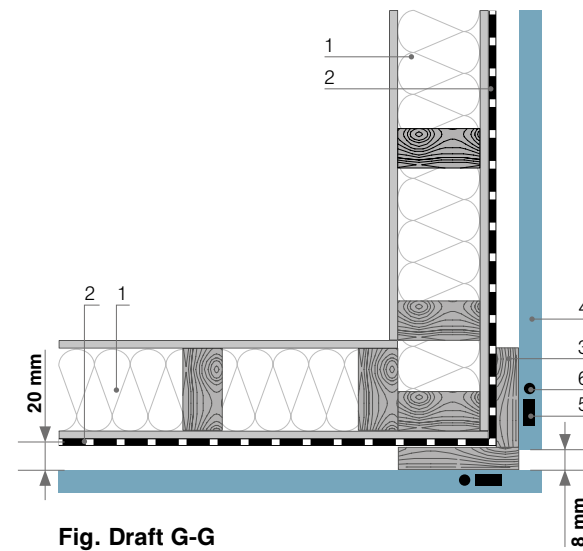

Fig. Draft G-G
Connector at the outer corner

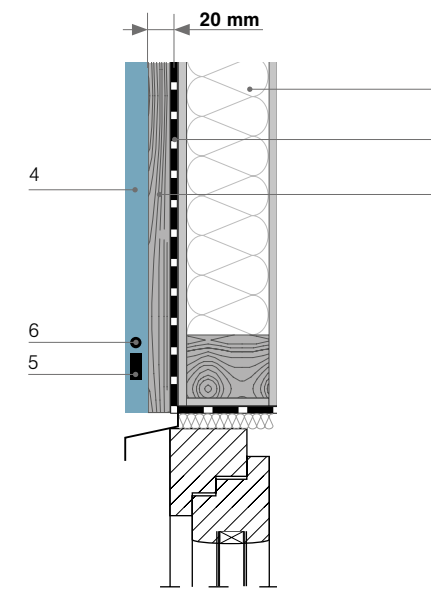
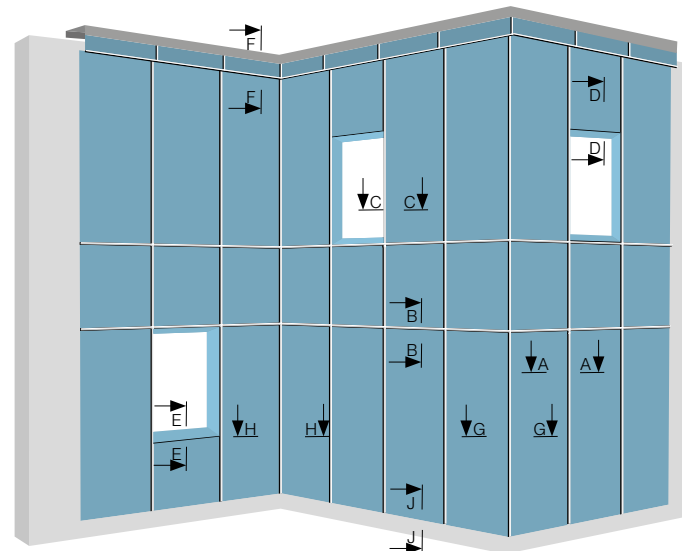

Fig. Draft D-D
Connector with window element (external)

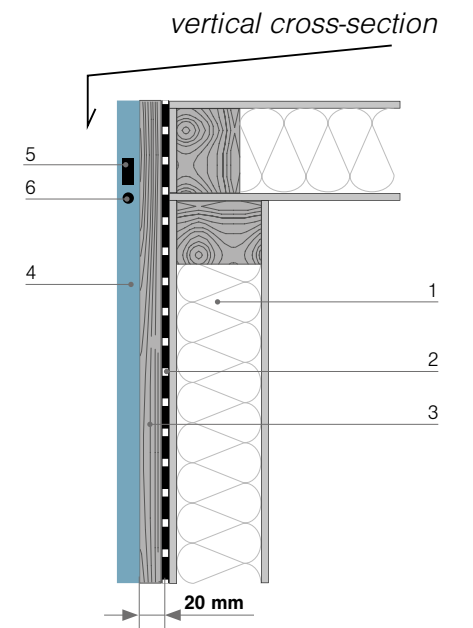

Fig. Draft F-F
Upper part of the wall with closing frame

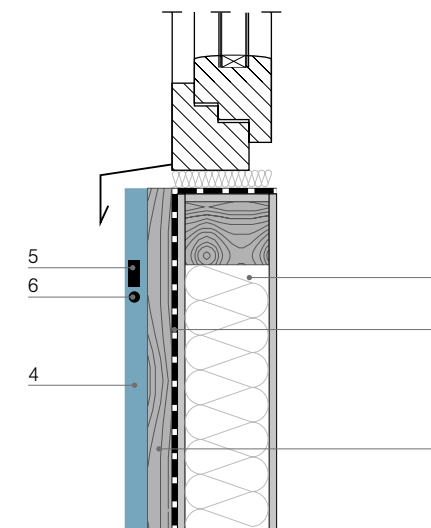

Fig. Draft E-E
External window sill

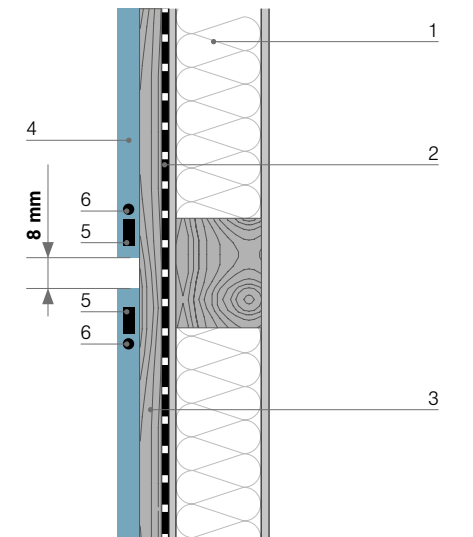

Fig. Draft B-B
Beam connector

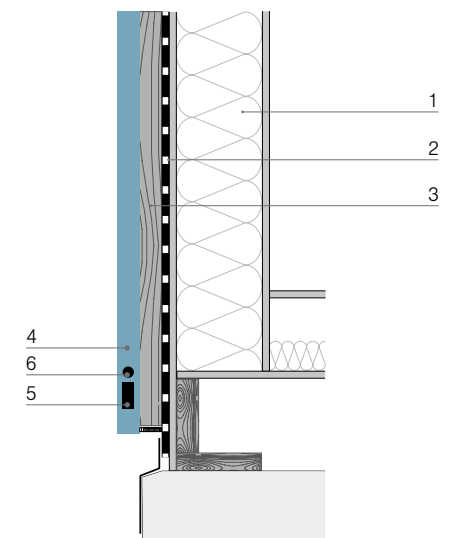

Fig. Draft J-J
Bottom part of the wall

1. Load bearing wall
2. Windproofing
3. Vertical timber batten
4. Kronoart® panels
5. Foam tape
6. Adhesive

Balcony Installation



General information

Kronoart® is highly suited to forming balustrades, from both the aesthetic and safety perspectives. It's an excellent alternative to concrete or glass in these applications, as both those materials have low impact strength, less durability and limited color options compared to Kronoart®.

Kronoart® panels are also easily maintained and keep their good looks over the long term.

There are many fixing options available, which adds greater flexibility in your specification process:

- Fitting to posts using fasteners or clamps
- Fitting to posts - in modules
- Fitting to posts - continuous
- Fitting to posts using profiles

Installation is generally performed using bolts, screws, self-drilling connectors or blind rivets affixed to aluminum or steel profiles.

Fixed point / Non-fixed point

To ensure uniform arrangement of panels, one fixed point should be made in the center of the panel. Other attachment points should be made as non-fixed-points. This mode of installation guarantees an even panel face in both lengthwise and crosswise planes. The diameter of the fixed-point hole should be the same as the fastener used. The diameters of holes for non-fixed points should be 1.5 times larger than the diameter of the respective fasteners. The fixed point for one-span fixing should be in the centre of the panel edge.

	Thickness [mm]	max. D [mm]	max. B [mm]	a [mm]	b [mm]
One-span fixing					
	6	400	400	20 - 40	20
	8	550	500	20 - 40	20
	10	700	600	20 - 40	20

Tab. Distribution of joints - one span fixing

The fixed point for multi-span fixing should be made in the center of the panel.

	Thickness [mm]	max. D [mm]	max. B [mm]	a [mm]	b [mm]
Multi-span fixing					
	6	550	400	20 - 60	20 - 50
	8	700	500	20 - 80	20 - 60
	10	800	600	20 - 100	20 - 80

Tab. Distribution of joints - multi span fixing

Bending

Kronoart® panels can be formed into a curve without any special preparation – the physical and chemical properties of its laminate structure make this possible. The minimum bend radius achievable is: $R = 2$ m.

Compensating for dimensional variance

Kronoart®'s base material means some dimensional variance is expected according to changes in humidity and temperature – it behaves in much the same way as wood. It's therefore necessary to incorporate suitable expansion gaps between panels.

- Minimum 8 mm, 2.5 mm per every meter of the panel both lengthwise and crosswise
- 5 mm around the panel for installation in profiles.

If joining profiles are used, allow for the thickness of their body.

Balustrades

A balustrade system incorporating Kronoart® panels should have strength and be sufficiently durable. The height of balcony balustrades should conform to local building regulations. Its height should be not less than 100 cm, and for buildings over 12 m, it should be at least 110 cm high.

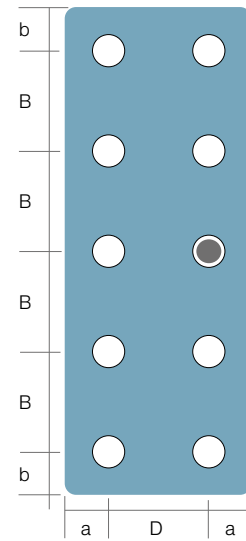
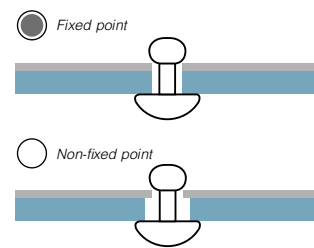

Fig. One-span fixing

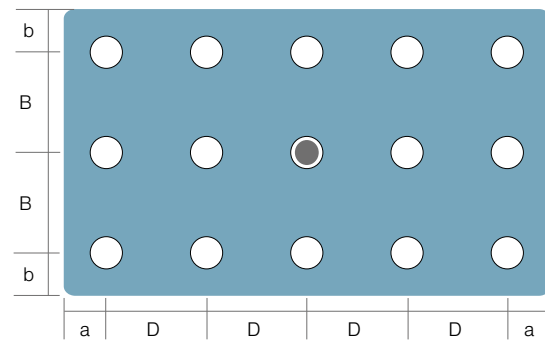

Fig. Multi-span fixing

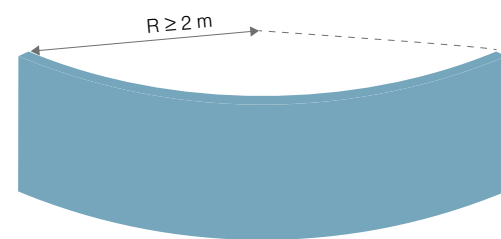

Fig. Bending of balcony panels

Balcony corners

With many corner form options, Kronoart® can fulfil different aesthetic and technical demands.

Open corners

The front panel is positioned over the side panels, revealing the natural color of the board at its vertical edges.

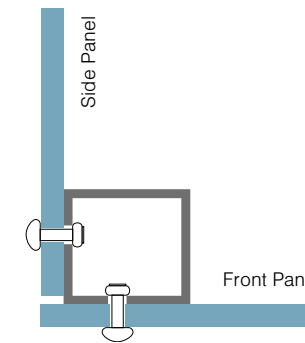

Masking uneven substructures

If supports are running out of true, by over-projecting the facing panel by around 10 mm each end it's possible to achieve a neat straight appearance.

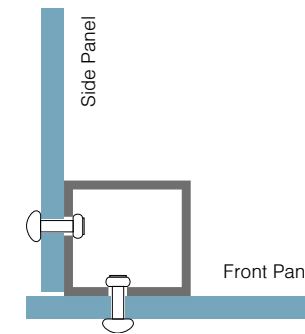

Corners joined slantwise

With precise cutting of the panels at 45°, this method delivers a neat, uniform appearance.

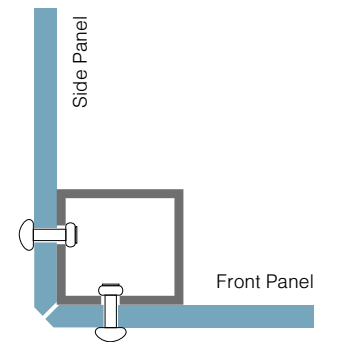

Corners finished with profiles

The open edges of the side and front panels are concealed by a powder-coated profile, in any RAL color.

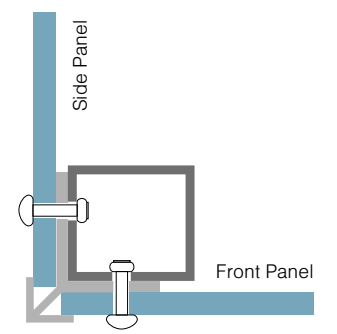

Fixing of supporting posts

Suitable balustrade supports must be firmly fixed to the floor of the balcony. These are usually tubes or profiles of a rectangular cross section. The fasteners utilized to secure the posts must ensure the safety of the construction and its stability.

Banisters can be mounted three ways

Upper mounting

Fixing the frame to the balcony floor is a common method.

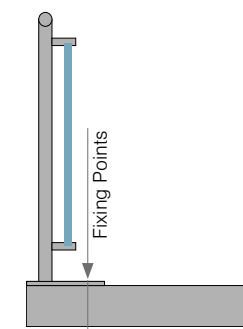

Side mounting

The frame can be mounted to the outer face of the balcony floor, eliminating the risk of leaks and thermal bridges.

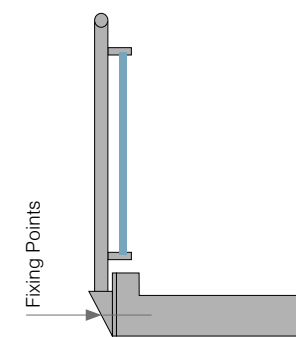

Lower mounting

As the balcony floor is untouched, there's no potential for water ingress to the structure, and optimal use is made of the floor area.

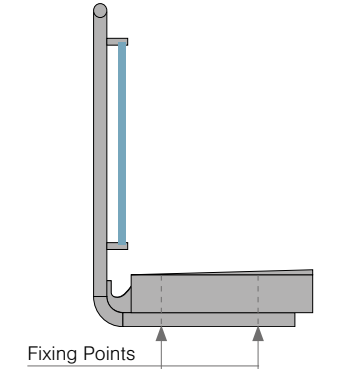

Installation of balcony panelling

Visible fixing to posts using fasteners of clamps

- A** Balustrade height
- B** Fixing distance
- C** Panel height
- D** Upper limit distance
- E** Lower limit distance
- F** Distance between connectors
- G** Panel projections
- H** Limit distance
- I** Free projections
- J** Fixing points

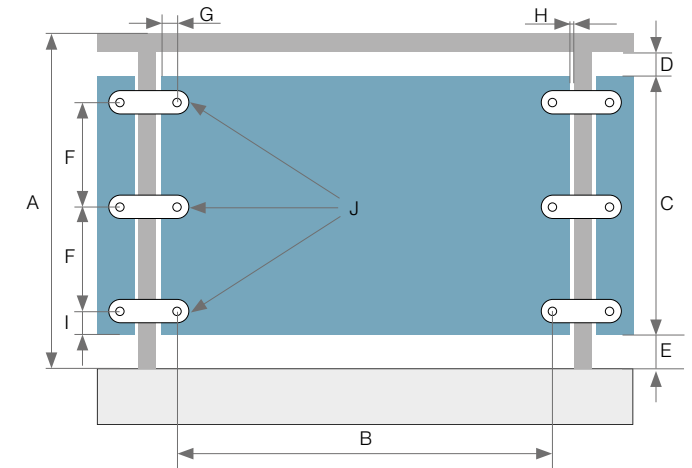

Panel thickness [mm]	A [cm]	B max. [mm]	C min./max. [mm]	D min./max. [mm]	E [mm]	F max. [mm]	G min./max. [mm]	H min./max. [mm]	I min./max. [mm]	J
6	90	600	700 - 780	40 - 120	40	300	20 - 40	20 - 40	50 - 90	3
	110		900						20 - 150	3
	110		905 - 980						20 - 40	4
8	90	700	700 - 780	40 - 120	40	300	20 - 40	20 - 40	50 - 90	3
	110		900						20 - 150	3
	110		905 - 980						20 - 40	4
10	90	800	700 - 780	40 - 120	40	300	20 - 40	20 - 40	50 - 90	3
	110		900						20 - 150	3
	110		905 - 980						20 - 40	4

Tab. Spacing of connectors - recommendation

Visible fixing to posts - in modules

- A** Balustrade height
- B** Fixing distance
- C** Panel height
- D** Upper limit distance
- E** Lower limit distance
- F** Distance between connectors
- G** Panel projections
- H** Panel projections
- I** Fixing points

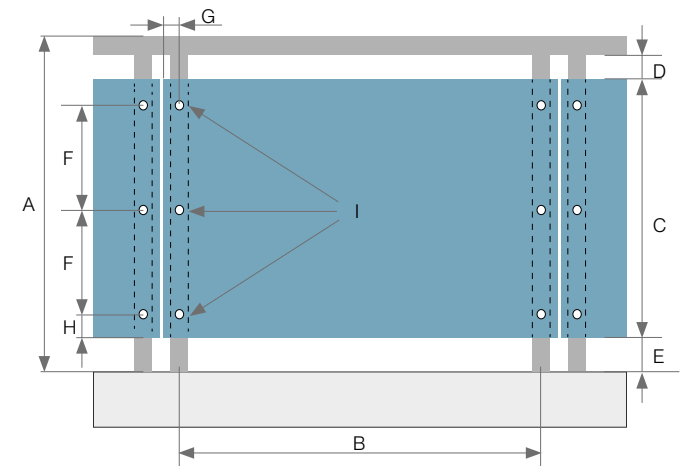

Panel thickness [mm]	A [cm]	B max. [mm]	C min./max. [mm]	D min./max. [mm]	E [mm]	F max. [mm]	G min./max. [mm]	H min./max. [mm]	I
6	90	600	700 - 780	40 - 120	40	300	20 - 40	50 - 90	3
	110		900					20 - 150	3
	110		905 - 980					20 - 40	4
8	90	700	700 - 780	40 - 120	40	300	20 - 40	50 - 90	3
	110		900					20 - 150	3
	110		905 - 980					20 - 40	4
10	90	800	700 - 780	40 - 120	40	300	20 - 40	50 - 90	3
	110		900					20 - 150	3
	110		905 - 980					20 - 40	4

Tab. Spacing of connectors - recommendation

Visible fixing to posts - continuous

- A** Balustrade height
- B** Distance between posts
- C** Panel height
- D** Upper limit distance
- E** Lower limit distance
- F** Distance between connectors
- G** Panel projections
- H** Limit distance
- I** Fixing points

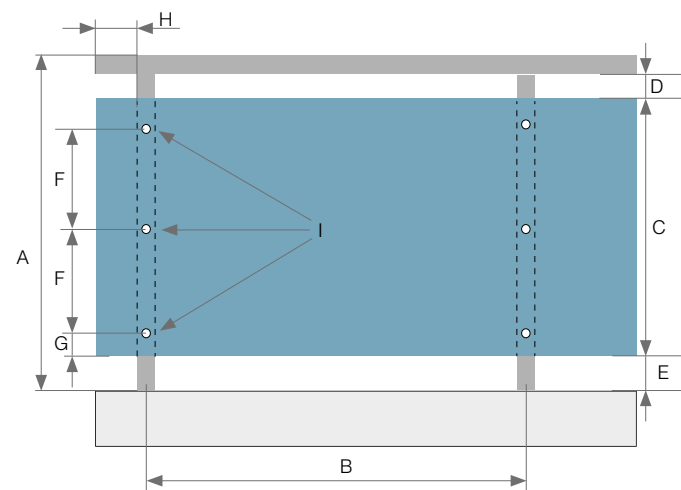

Panel thickness [mm]	A [cm]	B max. [mm]	C min./max. [mm]	D min./max. [mm]	E [mm]	F max. [mm]	G min./max. [mm]	H min./max. [mm]	I
6	90	600	700 - 780	40 - 120	40	300	20 - 40	20 - 40	3
	110		900						3
	110		905 - 980						4
8	90	700	700 - 780	40 - 120	40	300	20 - 40	20 - 40	3
	110		900						3
	110		905 - 980						4
10	90	800	700 - 780	40 - 120	40	300	20 - 40	20 - 40	3
	110		900						3
	110		905 - 980						4

Tab. Spacing of connectors - recommendation

Visible fixing to posts using profiles

- B** Distance between posts
- C** Panel height
- D** Upper limit distance
- E** Lower limit distance
- F** Support of balustrade posts
- G** Depth of insertion into profile
- H** Distance between panels

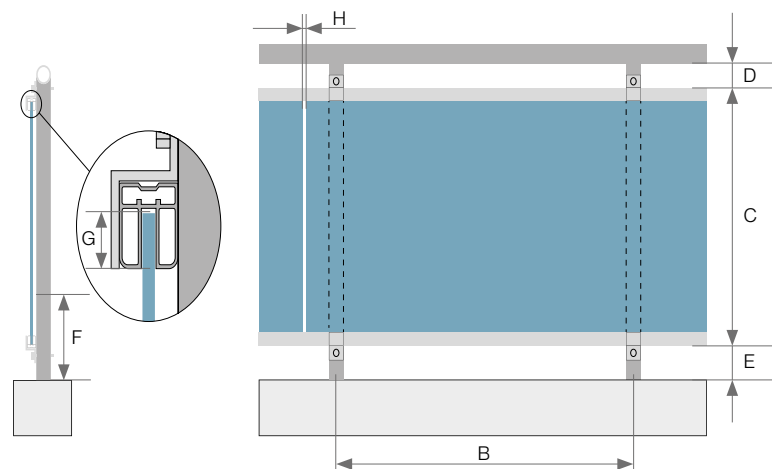

Panel thickness [mm]	Height of balustrade elements max. [cm]	B max. [mm]	C min./max. [mm]	D min./max. [mm]	E [mm]	F max. [mm]	G min. [mm]	H min./max. [mm]
6	131,5	1000	1045	120	40	300	20	6
8	156,5	1200	1100	120	40	300	20	8

Tab. Spacing of connectors - recommendation

Visible fixing to locks - continuous

- A** Balustrade height
- B** Distance between posts
- C** Panel height
- D** Upper limit distance
- E** Lower limit distance
- F** Distance between locks
- G** Panel projections
- H** Panel projections
- I** Distance between panels

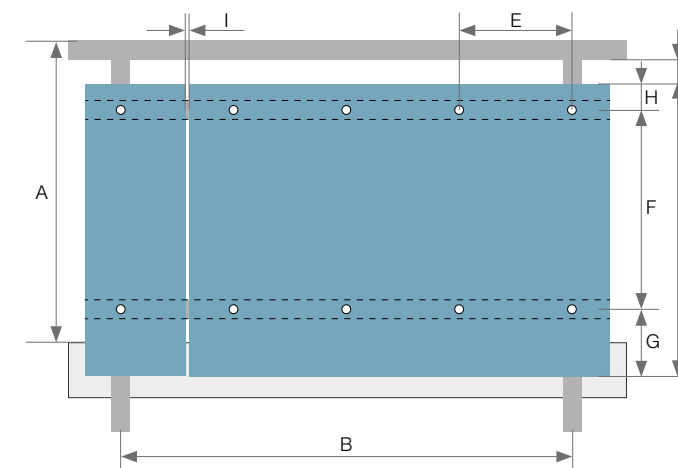

Panel thickness [mm]	A [cm]	B max. [mm]	C min./max. [mm]	D min./max. [mm]	E [mm]	F max. [mm]	G max. [mm]	H max. [mm]	I [mm]
6	110	1160	1050	40 - 120	300	820	150	80	6
8	110	1200	1180	40 - 120	300	950	150	80	8
10	110	1500	1280	40 - 120	300	1050	150	80	8

Tab. Spacing of connectors - recommendation

Visible fixing to locks - in modules

- A** Balustrade height
- B** Distance between posts
- C** Panel height
- D** Upper limit distance
- E** Lower limit distance
- F** Distance between connectors
- G** Distance between locks
- H** Distance between locks
- I** Panel projections
- J** Panel projections
- K** Distance between panels

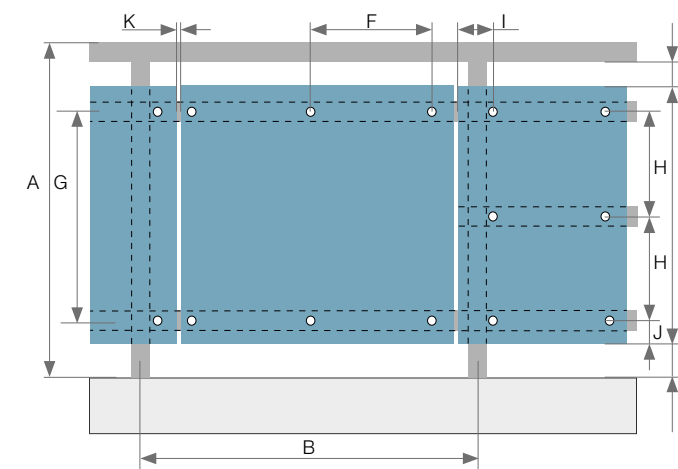

Panel thickness [mm]	A [cm]	B max. [mm]	C min./max. [mm]	D min./max. [mm]	E [mm]	F max. [mm]	G max. [mm]	H max. [mm]	I [mm]	J [mm]	K [mm]
6	90	600	700 - 780	40 - 120	40	300	600	430 470	20 - 40	50 - 90	3
	110		900							20 - 150	3
	110		905 - 980							20 - 40	4
8	90	700	700 - 780	40 - 120	40	300	700	430 470	20 - 40	50 - 90	3
	110		900							20 - 150	3
	110		905 - 980							20 - 40	4
10	90	800	700 - 780	40 - 120	40	300	700	430 470	20 - 40	50 - 90	3
	110		900							20 - 150	3
	110		905 - 980							20 - 40	4

Tab. Spacing of connectors - recommendation

Balcony partitions

Fitting partitions within balcony spaces can solve a number of design issues – providing privacy, weather protection, sun shading, for example. Partitions can also form part of features such as pergolas, storage spaces and shelters, and also define access routes. Kronoart® panels are ideally suited to partitioning roles. The method of connecting the partition to the wall and the balustrade will vary according to the panel size, and what its function will be.

Method of partition installation

The following methods are recommended:

- Framing with a profile from all sides
- Framing to lacing from galvanized steel
- Fitting to profiles using rivets and screws

The Kronoart® panels may be fitted to profiles by rivets or balcony bolts.

Framing profiles from all sides

The dimensions of profiles should match the thickness of panels, taking into consideration the dimension tolerances and possible sealing with EPDM.

It is important to enable free panel movement by maintaining a distance from the side and upper profiles - minimum 5 mm. Suitable water drainage should be enabled, by matching the slotted holes or by drilling holes in the lower profile. Below are recommendations for spacing of connectors where:

L_{max} is the largest admissible spacing of fitting elements for given height to width ratio (H/L) of the partition under design and for the selected panel thickness.

C_2 is the distance between the profile edge and the floor; it should be 20-fold of laminate thickness (maximum value).

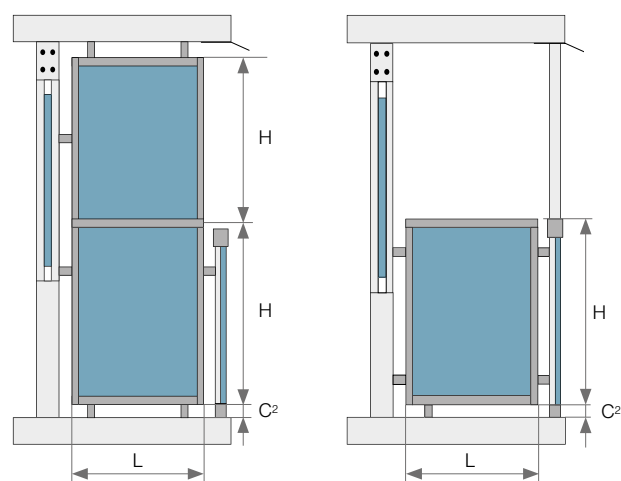

	H/L	Panel thickness [mm]			
		6	8	10	13
Framing from 4 sides	0.98	765	1029	1284	1666
	1.18	725	960	1196	1558
	1.38	686	902	1127	1470
	1.58	647	853	1068	1392
	1.78	608	813	1019	1323
	1.98	578	774	970	1264
Framing from 2-3 sides	>2.48	559	745	931	1206
		Max. spacing L_{max} [mm]			

Tab. Spacing of bearing profiles, maximum distances

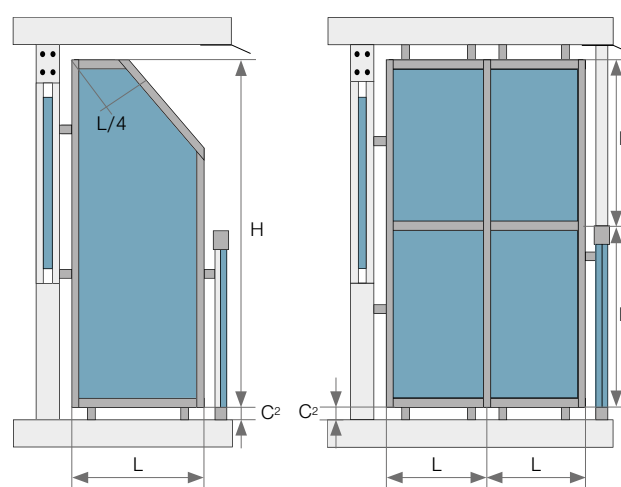

Fitting to steel lacings

Below are given the recommended spacing for connectors where: D_1 is maximum distance between the fitting elements for one-span fitting, and Z_1 is the largest admissible spacing of fitting elements for multi-span fitting for the selected panel thickness:

- C_1 - distance between the holder and the laminate edge, 20-150 mm,
- C_2 - distance between the lower edge and the floor, min. 149 mm,
- C_3 - distance between the edge of upper profile and the holder, 20-150 mm.

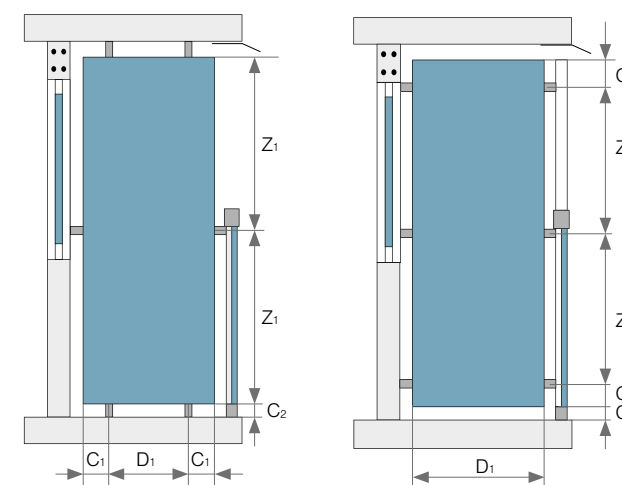

Panel thickness [mm]	6	8	13
D_1 [mm]	588	735	931
Z_1 [mm]	735	882	1176

Tab. Spacing of bearing profiles, maximum distances

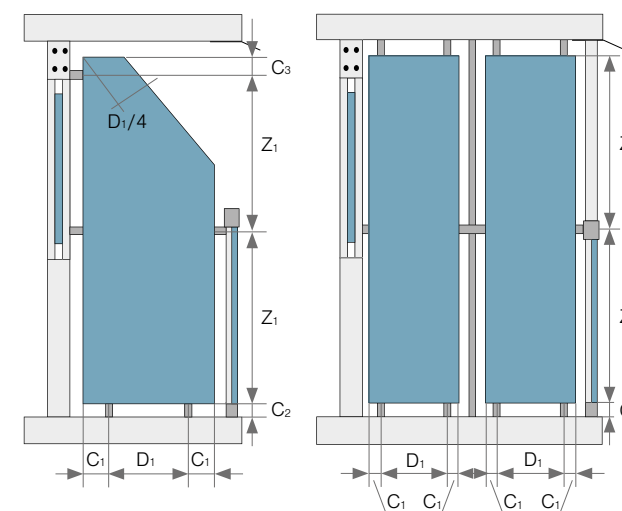

Fitting to profiles with rivets or balcony bolts

Below are given the recommended spacing of connectors where L_{max} is maximum distance between the fitting elements depending on the panel thickness and number of fitting spans.

- C_1 - 149 mm (minimum value),
- C_2 dimension = 20-fold of laminate thickness (maximum value).

Panel thickness [mm]	6	8	10	13
L_{max} (single span) [mm]	539	539	931	1176
L_{max} (multi span) [mm]	686	882	1127	1470

Tab. Spacing of bearing profiles, maximum distances

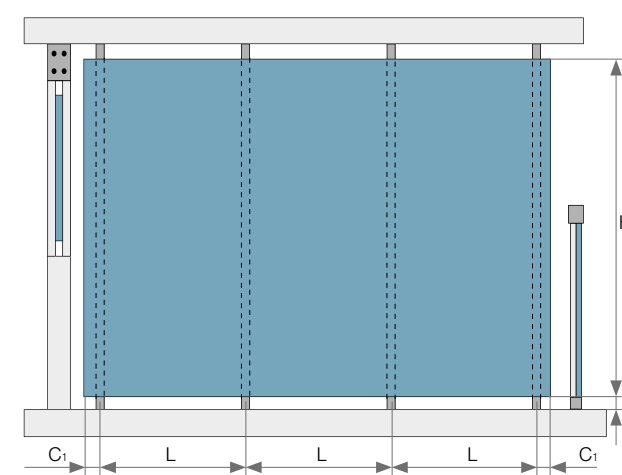

Fastenings for balconies

Coated rivets

Large head, powder coated rivets can be used as visible fixings on balconies, secured to aluminum aluminium supporting elements in line with relevant regulations.

Element	Type of material	No of material
Sleeve	Al Mg 5	3.3555.10
Stem	stainless steel	1.4541 (Alfo®); 1.4301 (SFS)

Tab. Parameters of blind rivets.

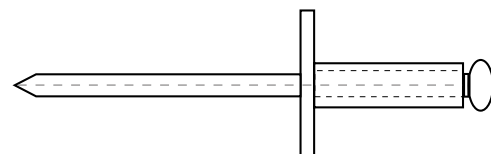

Fig. Blind rivet, closed from one side, painted

Diameter Ø d / length L [mm]	5/18	5/21
Max. thickness of material [mm]	12	15
Diameter Ø d1 [mm]	2.7	2.7
Diameter Ø D [mm]	14	14
Catalogue no. (Alfo®)	12250180/14	12250210/14
Catalogue no. (SFS)	AP1450180-S	AP1450210-S
Quantity	500 / carton	500 / carton

Tab. Technical data of the recommended connectors.

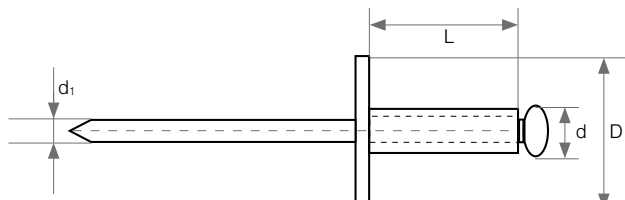

Fig. Blind rivet - construction and dimensions

Breaking force of the rivets is 4.4 – 5.2 kN.

In the majority of cases the specifications listed above can be followed for adequate fixing. Riveting tools and accessories are available, including manual and machine riveting options, distancing tips, centering tools for drilling, and a positioning tip for centering the preliminary hole.

Torx 20 screws

These are intended for use with timber supporting frames. They're made from corrosion resistant austenitic stainless steel, finished in powder coated colors. They can be used without washers, with single or double threads.

No of material	1.4301
Diameter Ø d2 [mm]	12
Diameter Ø d1 [mm]	5.2
Length L [mm]	24
Screw driver tip	TORX T20W
Pitch of the screw P [mm]	2.2

Tab. Technical data of fitting screws Torx

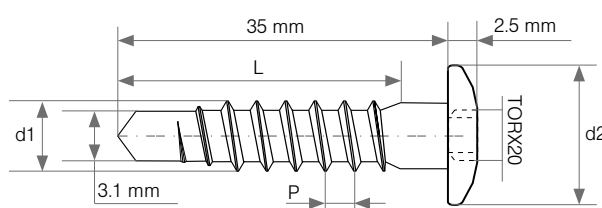

Fig. Fixing screw Torx - construction and dimensions

- d1 thread diameter
- d2 head diameter
- L length
- P pitch of the screw

Balcony screws

Our specialized screws enable fitting of Kronoart® panels with complete peace of mind. The joints are extremely secure, further enhanced by hermetic adhesive which locks the dome nuts in place.

The M5 screw has a stem of length (L) from 20 mm to 55 mm. The head with multi tooth seat is of the Phillips type, size 20, head diameter 16 mm. The screw, special nut and washer are made from stainless steel, blank A2.

They are shipped with self-adhesive polyamide pads, washer type "U", spring ring and special dome nut with a longer thread and a cap of the same color.

The fixings are packed in cartons containing 200 sets. Customized lengths are available on request.

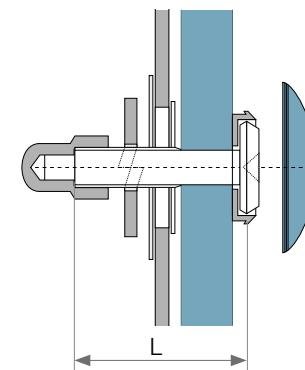

Fig. Construction and dimensions of balcony screw

Catalogue Nº of the screw	Stud length of the screw L [mm]
120 50 44 20	20
120 50 44 25	25
120 50 44 30	30
120 50 44 35	35
120 50 44 40	40
120 50 44 45	45
120 50 44 50	50
120 50 44 55	55

Supplier: MBE GmbH (Moderne Befestigungs-Elemente GmbH)

Self-drilling stainless steel fasteners

These SX-L12 (SFS) fasteners are designed to achieve a neat appearance for panels fitted to aluminum or steel bearing elements.

Special flat head L12 powder coated fasteners color match the facing and are almost invisible from a short distance away

Product	Type	VD	KL	HD	W	d	L	Application
A	SX	3/	15/	L12	S16	5.5x	32	VD max. steel: 3.0 mm t max. steel: 2.5 mm
B	SX	3/	15/	D12		5.5x	30	VD max. steel: 3.0 mm t max. steel: 2.5 mm
C	SX	3/	15/	D10/		5.5x	25	VD max. steel: 3.0 mm t max. steel: 2.5 mm t min. steel: 2.0 mm t min. aluminium: 2.0 mm

Tab. Symbols and parameters of connectors (SFS). All dimensions in mm.

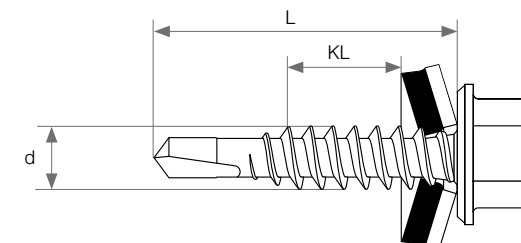
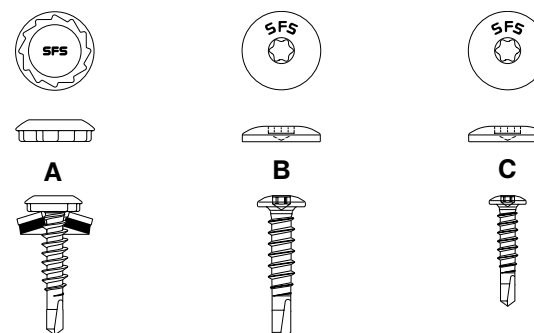

Fig. Self-drilling connector - construction

Heads of connectors, depending on version:

- L12 - irius® Ø 12 mm,
- D12 - flat head Ø 12 mm with a seat T25,
- D10 - flat head Ø 10 mm with a seat T20.



irius® Ø 12 mm flat head Ø 12 mm, with a seat T25 flat head Ø 10 mm, with a seat T20

- KL thickness of joined elements
- d thread diameter
- L total length
- VD maximum drilling capability
- HD type of head/ seat
- W material and diameter of washer
- t thickness of substrate

Installation Accessories

Balconies

Profile U for framing of partition wall panels

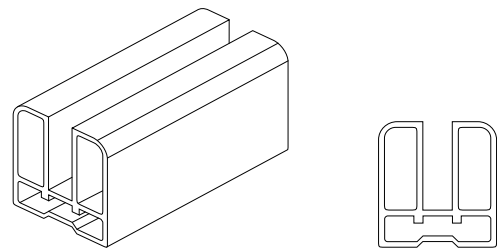

Fig. Profile U - cross section. Designation by the manufacturer (WIDO) - 00-100043.

Seals

Seal for the panels 6 mm

Profile A - 00-100076

Profile U - 00-100043

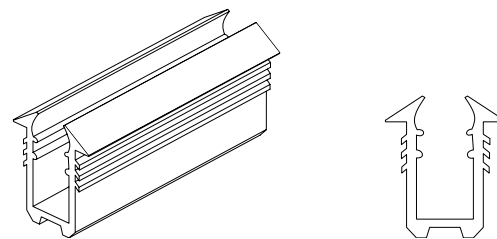

Fig. Seal for the panels 6 mm, designation by the manufacturer (WIDO) - 30-600038.

Seal for the panels 8 mm

Profile A - 00-100076

Profile U - 00-100043

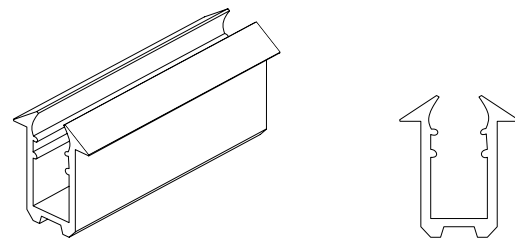

Fig. Seal for the panels 8 mm, designation by the manufacturer (WIDO) - 30-600039.

Facades

EPDM

Installation tape made from elastomer on basis of the modified EPDM is used for sealing the contacting surfaces between facade elements. It is very resistant to weather conditions and highly flexible. It keeps stable shape in elevated temperatures.

It is also available as one-sided adhesive tape facilitating the installation.



Item	DIN	Property
Class of building material	4102	B2 normally flammable
Water vapour diffusion resistance factor		- 40°C - +130°C
Temperature of use		+ 5°C - + 35°C
Durability		two years
Storage temperature		+ 5°C - + 25°C
Color		black

Tab. Technical details of EPDM tape

Type	Width [mm]	Thickness [mm]	Length [m/roll]
EPDM	70	0.8/1.2	25
EPDM	110	0.8/1.2	25
EPDM - Adhesive	70	0.8/1.2	25
EPDM - Adhesive	110	0.8/1.2	25

Tab. EPDM - examples of application

Supplier of Fittings

KEIL Befestigungstechnik GmbH

Im Auel 42
51766 Engelskirchen
Germany
T +49 2263 807-0
www.keil-fixing.de

Bostik Polska

ul. Poznańska 11B
62-080 Tarnowo Podgórze
Poland
T +48 61 663 88 86
www.bostik.com

MBE GmbH

Siemensstrasse 1
58706 Menden
Germany
T +49 2373 17430-0
www.mbe-gmbh.com

Wido-Profil Sp. z o.o.

ul. Mickiewicza 40
32-400 Myślenice
Poland
T +48 12 274 17 15
www.wido.pl

SFS Intec GmbH

In den Schwarzwiesen 2
61440 Oberursel/TS
Germany
T +49 6171 700 20
www.sfsintec.de

Disclaimer

The information provided in this document is for general information purposes only. Not all systems mentioned and presented in this document are suitable for all applications and areas. All customers and third parties are obliged to inform themselves in detail about Kronospan products and their suitability for specific purposes. We also strongly recommend that you and all other users of this document seek independent professional advice regarding compliance with local planning and application requirements, applicable laws, regulations, standards, guidelines and test standards. Technical details and print errors are subject to change.





kronospan-express.com

FOLLOW US



facebook.com/Kronospan



twitter.com/Kronospan



instagram.com/Kronospan



pinterest.com/Kronospan



youtube.com/KronospanWorldwide